

Nylon Cable Chains Protection Series

H57PC/PN Series	page 122
H80PC/PA Series	page 124
H110PC/PA Series	page 126
325PI Series	page 128
335PS Series	page 130
435PU Series	page 132
445PU Series	page 134
445PS Series	page 136
445AU Series	page 138
475PU Series	page 140
660 Series	page 142
770 Series	page 144
306CU Series	page 146
308CU Series	page 148
309C Series	page 150
309CU Series	page 152

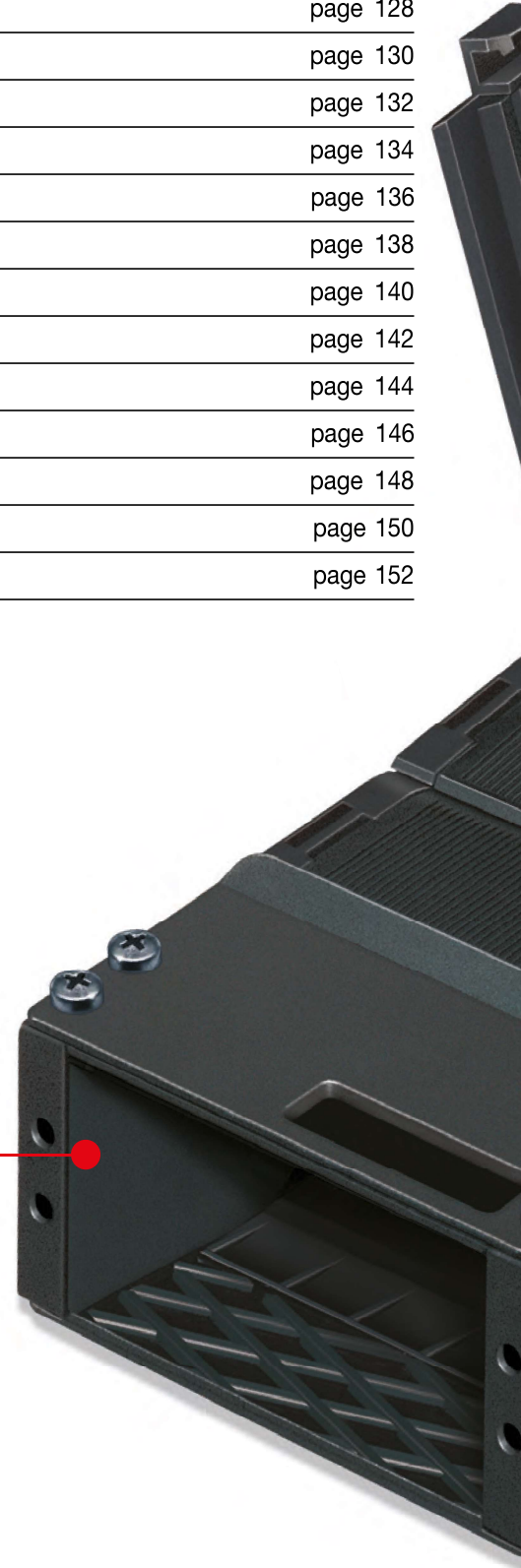

*Special End Brackets on
moving end of chain*



Quickly removable covers with a "Snap-Fit" action

Completely enclosed design to protect chain contents from steel and wood chips, dust, etc.

Inner surface of chain completely smooth

Nylon separator cables can be laid apart from each other

Connecting Pivot Pin which offers high integrity in high performance applications

4

H57PC

Nylon chain with opening aluminium or nylon covers

Inner height (D) 53,5 mm

Sideband construction with quickly removable pin.
Covers openable from either side on both inner and outer radius.
Vertical and horizontal modular separator system are available.

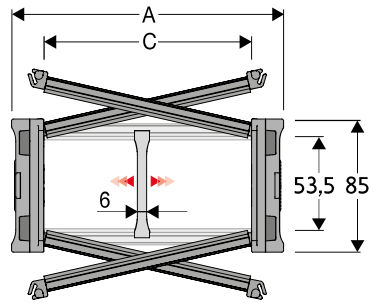

Separator

- Unassembled	Part.no S57UA
- Assembled	Part.no S57UAMCI
- Assembled	Part.no S57UAMCE
Pin	
	Part.no PNH57RS

* for chain opening outer radius
** for chain opening inner radius

Technical characteristics when self-supported

Speed	8 m/s
Acceleration	40 m/s ²

For higher requirements please consult our technical dept.

A	B	C	D	R	Weight/m	Chain
mm	mm	mm	mm	mm	kg	Part Number
113	85	75	53,5	180-200-250-300-350-400	4,23	H57PC075 □□□ *
138	85	100	53,5	180-200-250-300-350-400	4,67	H57PC100 □□□ *
163	85	125	53,5	180-200-250-300-350-400	5,11	H57PC125 □□□ *
188	85	150	53,5	180-200-250-300-350-400	5,56	H57PC150 □□□ *
213	85	175	53,5	180-200-250-300-350-400	6,00	H57PC175 □□□ *
238	85	200	53,5	180-200-250-300-350-400	6,43	H57PC200 □□□ *
263	85	225	53,5	180-200-250-300-350-400	6,88	H57PC225 □□□ *
288	85	250	53,5	180-200-250-300-350-400	7,32	H57PC250 □□□ *
313	85	275	53,5	180-200-250-300-350-400	7,77	H57PC275 □□□ *
338	85	300	53,5	180-200-250-300-350-400	8,21	H57PC300 □□□ *
388	85	350	53,5	180-200-250-300-350-400	9,09	H57PC350 □□□ *
438	85	400	53,5	180-200-250-300-350-400	9,98	H57PC400 □□□ *

*Complete the code by inserting the value of the radius (R): Ex. H57PC100 □□□ □

4

For sliding applications, characteristics techniques may vary depending on the frequency, added weight and work environment.

Separator

- Unassembled	Part.no S57CF3
- Assembled*	Part.no S57CF3MCI
- Assembled**	Part.no S57CF3MCE

* for chain opening outer radius
** for chain opening inner radius

H57PN Nylon covers version

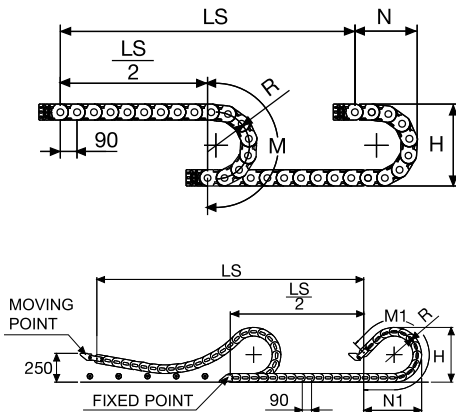

A	B	C	D	R	Weight/m	Chain
mm	mm	mm	mm	mm	kg	Part Number
188	85	150	57	150-180-200-250-300-350-400	4,47	H57PN150 □□□ *
238	85	200	57	150-180-200-250-300-350-400	4,92	H57PN200 □□□ *
288	85	250	57	150-180-200-250-300-350-400	5,45	H57PN250 □□□ *

*Complete the code by inserting the value of the radius (R): Ex. H57PN188 □□□ □

**H57PN with R 150: not to be used in sliding applications.

Length of chain (L)

Half travel distance ($\frac{LS}{2}$)

plus length of curve (M) or (M1)

$$L = \frac{LS}{2} + M \text{ or } M1$$

R	H	N	M	N1	M1
mm	mm	mm	mm	mm	mm
150**	385	283	655	-	-
180	445	430	750	705	1570
200	485	480	810	805	1795
250	585	530	970	1040	2350
300	685	580	1125	1275	2905
350	785	680	1280	1510	3460
400	885	780	1440	1750	4020



Self-Supporting Capacity Diagram

The maximum length of the self-supporting capacity or in admissible sagging ($\frac{LS}{2}$) in relationship to the weight of the cables and hoses contained per linear metre.

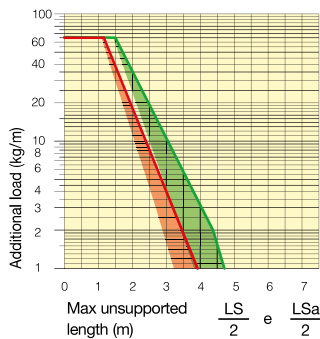

The area in the diagram considers the difference of weight between various widths of chain.

Red for self-supporting chain, green for chain in admissible sagging.

For applications with ($\frac{LS}{2}$) and weights not included in the diagram of self-supporting capacity, verify the possible use of support rollers (see page 30).

End Brackets

The end brackets set allows the two ends of the chain to be attached to the equipment. Set complete with tie-wrap clamps available on request.

Nylon version

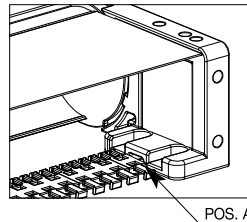
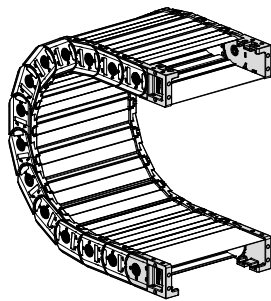
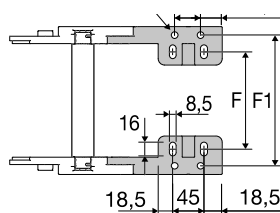
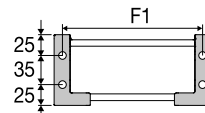
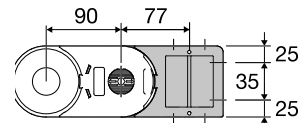

Fig. A The chain can be fixed frontally, inner or outer radius. (Fig A)



Chain Type	F mm
H57PC075	51
H57PC100	76
H57PC125	101
H57PC150	126
H57PC175	151
H57PC200	176
H57PC225	201
H57PC250	226
H57PC275	251
H57PC300	276
H57PC350	326
H57PC400	376

Nylon Type Part Numbers

Complete Set Assemble	Chain	End Brackets
Type	Set	
H57P...	ANH57P	□□□*KM□**

Complete Set Unassemble	Chain	End Brackets
Type	Set	
H57P...	ANH57P	□□□*K

** 1=Pos.1; 2=Pos.2; 3=Pos.3

Chain Type	F1 mm
H57PC075	98
H57PC100	123
H57PC125	148
H57PC150	173
H57PC175	198
H57PC200	223
H57PC225	248
H57PC250	273
H57PC275	298
H57PC300	323
H57PC350	373
H57PC400	423

Tiewrap Clamp

Complete Set Assembled	Mounting	Tiewrap Clamp
Position	set	
Pos. A	SFCTH57	□□□*KMA

Complete Set Unassembled	Mounting	Tiewrap Clamp
Position	set	
Pos. A	SFCTH57	□□□*KA

* Inner Width C

Serie Protection

H57PC

Nylon chain with opening aluminium covers

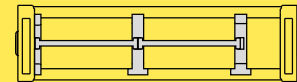

Separation System To choose the separators see page 216

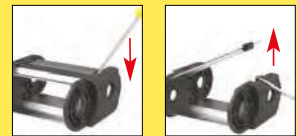

How to open the cover

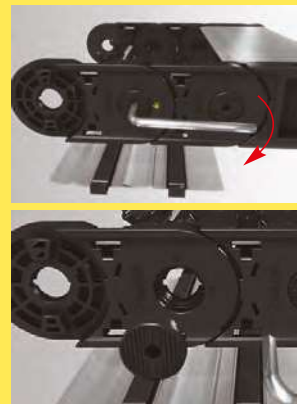

Easy opening of the pin junction.

Allen key for the opening of the pin

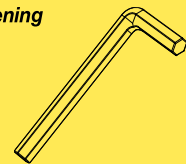

Suitable to long travel distance. See page 182

For further information please consult Brevetti Stendalto's Technical Office



H80PC

Nylon chain with aluminium covers

Inner height (D) 77 mm

Sideband construction with quickly removable pin. Covers openable from either side on both inner and outer radius. Vertical and horizontal modular separator system are available.

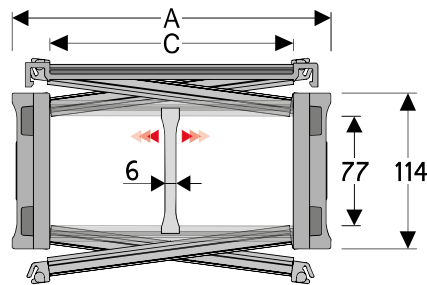

Separator

- Unassembled	Part.no SH80SCF6
- Assembled*	Part.no SH80SCF6MCI
- Assembled**	Part.no SH80SCF6MCE

* for chain opening outer radius
** for chain opening inner radius

Technical characteristics when self-supported

Speed	8 m/s
Acceleration	40 m/s ²

For higher requirements please consult our technical dept.

A	B	C	D	R	Weight/m	Chain
mm	mm	mm	mm	mm	kg	Part Number
205	114	150	77	200-250-300-350-400-500-600	8,51	H80PC150 □□□*
230	114	175	77	200-250-300-350-400-500-600	8,98	H80PC175 □□□*
255	114	200	77	200-250-300-350-400-500-600	9,44	H80PC200 □□□*
280	114	225	77	200-250-300-350-400-500-600	9,91	H80PC225 □□□*
305	114	250	77	200-250-300-350-400-500-600	10,38	H80PC250 □□□*
330	114	275	77	200-250-300-350-400-500-600	10,83	H80PC275 □□□*
355	114	300	77	200-250-300-350-400-500-600	11,27	H80PC300 □□□*
380	114	325	77	200-250-300-350-400-500-600	11,77	H80PC325 □□□*
405	114	350	77	200-250-300-350-400-500-600	12,26	H80PC350 □□□*
430	114	375	77	200-250-300-350-400-500-600	12,74	H80PC375 □□□*
485	114	430	77	200-250-300-350-400-500-600	13,79	H80PC430 □□□*
555	114	500	77	200-250-300-350-400-500-600	15,15	H80PC500 □□□*

*Complete the code by inserting the value of the radius (R): Ex. H80PC150 □ □ □ □

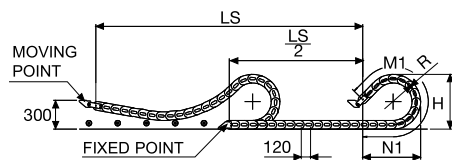
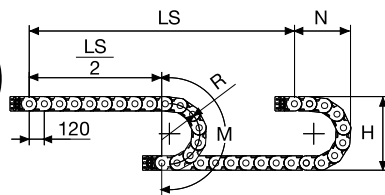

For sliding applications, characteristics techniques may vary depending on the frequency, added weight and work environment.

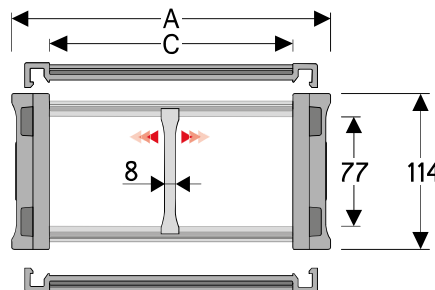

Separator

- Unassembled	Part.no S80F
- Assembled*	Part.no S80FMCI
- Assembled**	Part.no S80FMCE

Pin

Cod. PNH80RS

* for chain opening outer radius
** for chain opening inner radius

R	H	N	M	N1	M1
mm	mm	mm	mm	mm	mm
200	514	377	870	810	1775
250	614	427	1030	1050	2330
300	714	477	1185	1285	2885
350	814	527	1340	1525	3445
400	914	577	1500	1760	4000
500	1114	677	1815	2235	5115
600	1314	777	2125	2705	6225

H80PA

Version with openable covers by both sides

A	B	C	D	R	Weight/m	Chain
mm	mm	mm	mm	mm	kg	Part Number
129	114	74	77	200-250-300-350-400-500-600	6,78	H80PA074 □□□*
149	114	94	77	200-250-300-350-400-500-600	7,18	H80PA094 □□□*
174	114	119	77	200-250-300-350-400-500-600	7,61	H80PA119 □□□*
181	114	126	77	200-250-300-350-400-500-600	7,74	H80PA126 □□□*

*Complete the code by inserting the value of the radius (R): Ex. H80PA119 □ □ □ □



Self-Supporting Capacity Diagram

The maximum length of the self-supporting capacity or in admissible sagging ($\frac{LS}{2}$) in relationship to the weight of the cables and hoses contained per linear metre.

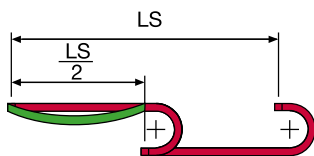
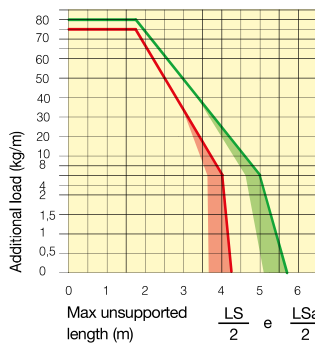

The area in the diagram considers the difference of weight between various widths of chain.

Red for self-supporting chain, green for chain in admissible sagging.

For applications with ($\frac{LS}{2}$) and weights not included in the diagram of self-supporting capacity, verify the possible use of support rollers (see page 30).

Length of chain (L)
Half travel distance ($\frac{LS}{2}$)
plus length of curve (M) or (M1)

$$L = \frac{LS}{2} + M \text{ or } M1$$

End Brackets

The end brackets set allows the two ends of the chain to be attached to the equipment. Set complete with tie-wrap clamps available on request.

Nylon Version

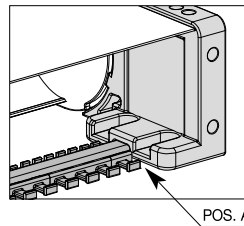
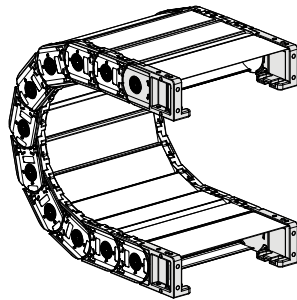
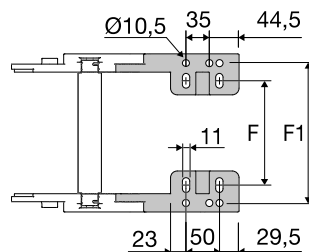
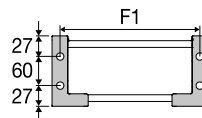
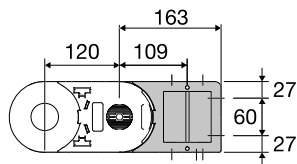

Fig. A
The chain can be fixed frontally, inner or outer radius. (Fig A)



Chain Type	F mm	F1 mm
H80PC150	124	177,5
H80PC175	149	202,5
H80PC200	174	227,5
H80PC225	199	252,5
H80PC250	224	277,5
H80PC275	249	302,5
H80PC300	274	327,5
H80PC325	299	352,5
H80PC350	324	377,5
H80PC375	349	402,5
H80PC430	404	457,5
H80PC500	474	527,5
H80PA074	48	101,5
H80PA094	68	121,5
H80PA119	93	146,5
H80PA126	100	153,5

Nylon Type Part Numbers

Complete Set Assembled

Chain Type	End Brackets Set
H80PC	ANH80P□□□*KM□**

Complete Set Unassembled

Chain Type	End Brackets Set
H80PC	ANH80P□□□*K

* Inner width C
** 1=Pos.1; 2=Pos.2; 3=Pos.3

Tiewrap Clamp

Pos. A	Part Number
Assembled	SFCTH80□□□*KMA
Unassembled	SFCTH80□□□*KA

* Inner width C
** Not available for quote C 074 and C 094

Serie Protection

H80PC

Nylon chain with aluminium covers

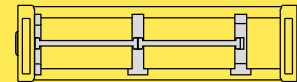

Separation System To choose the separators see page 216



How to open the cover

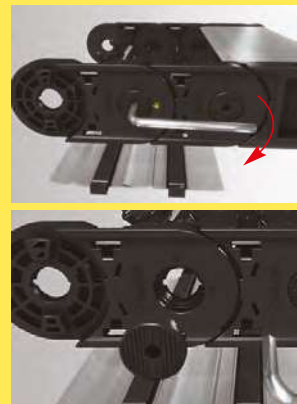

Easy opening of the pin junction.

Allen key for the opening of the pin

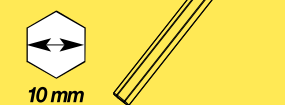

Suitable to long travel distance. See page 184

For further information please consult Brevetti Stendalto's Technical Office



H110PC

Nylon chain with opening aluminium covers

Inner height (D) 107 mm

Sideband construction with quickly removable pin.

Covers openable from either side on both inner and outer radius. Vertical and horizontal modular separator system are available.

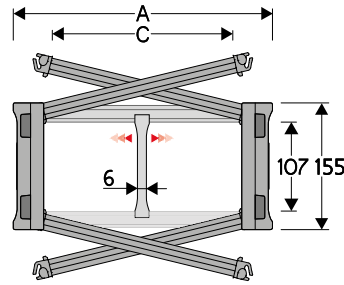

Separator

- Unassembled	Part.no S110F3
- Assembled*	Part.no S110F3MCI
- Assembled**	Part.no S110F3MCE

Pin

Part.no PNH110RS

* for chain opening outer radius
** for chain opening inner radius

Technical characteristics when self-supported

Speed	10 m/s
Acceleration	50 m/s ²

For higher requirements please consult our technical dept.

For sliding applications, characteristics techniques may vary depending on the frequency, added weight and work environment.

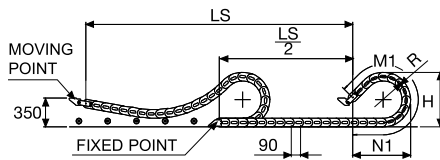
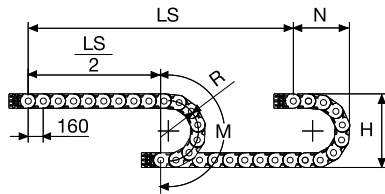

A	B	C	D	R	Weight/m	Chain
mm	mm	mm	mm	mm	kg	Part Number
205	155	150	107	250-300-400-500-600-700-750	11,06	110PC150 □□□*
230	155	175	107	250-300-400-500-600-700-750	11,59	110PC175 □□□*
255	155	200	107	250-300-400-500-600-700-750	12,11	110PC200 □□□*
280	155	225	107	250-300-400-500-600-700-750	12,63	110PC225 □□□*
305	155	250	107	250-300-400-500-600-700-750	13,16	110PC250 □□□*
330	155	275	107	250-300-400-500-600-700-750	13,67	110PC275 □□□*
355	155	300	107	250-300-400-500-600-700-750	14,18	110PC300 □□□*
380	155	325	107	250-300-400-500-600-700-750	14,73	110PC325 □□□*
405	155	350	107	250-300-400-500-600-700-750	15,30	110PC350 □□□*
430	155	375	107	250-300-400-500-600-700-750	15,81	110PC375 □□□*
485	155	430	107	250-300-400-500-600-700-750	16,98	110PC430 □□□*
555	155	500	107	250-300-400-500-600-700-750	18,49	110PC500 □□□*

*Complete the code by inserting the value of the radius (R): Ex. 110PC350 □□□□

R	H	N	M	N1	M1
mm	mm	mm	mm	mm	mm
250	657	468	1110	1095	2375
300	757	518	1265	1335	2935
400	957	618	1580	1805	4045
500	1157	718	1895	2280	5160
600	1357	818	2205	2750	6270
700	1557	918	2520	3225	7385
750	1657	968	2680	3460	7940



Self-Supporting Capacity Diagram

The maximum length of the self-supporting capacity or in admissible sagging ($\frac{LS}{2}$) in relationship to the weight of the cables and hoses contained per linear metre.

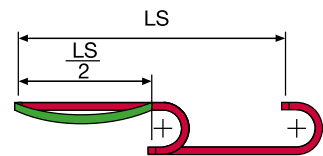
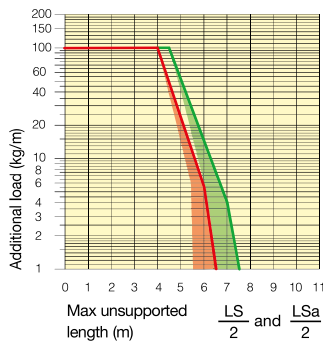

The area in the diagram considers the difference of weight between various widths of chain.

Red for self-supporting chain, green for chain in admissible sagging.

For applications with ($\frac{LS}{2}$) and weights not included in the diagram of self-supporting capacity, verify the possible use of support rollers (see page 30).

Length of chain (L)

Half travel distance ($\frac{LS}{2}$) plus length of curve (M) or (M1)

$$L = \frac{LS}{2} + M \text{ or } M1$$

Bright Zinc Plated Steel End Brackets

The end brackets set allows the two ends of the chain to be attached to the equipment. Set complete with tie-wrap clamps available on request.

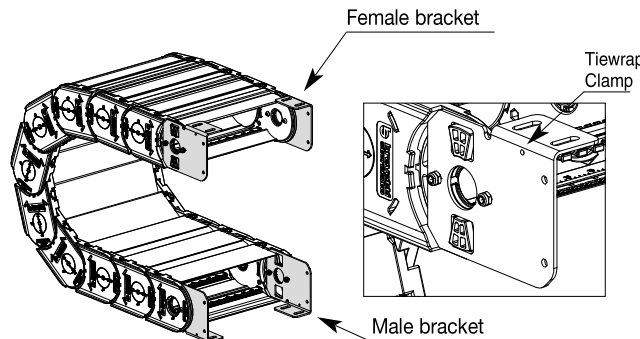
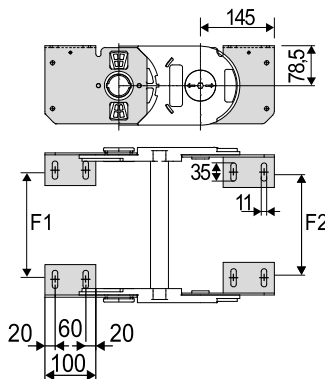

Fig. A Chain fixed outside or inside the radius. (Fig A)



Chain Type	F1 mm
110PC150	120
110PC175	145
110PC200	170
110PC225	195
110PC250	220
110PC275	245
110PC300	270
110PC325	295
110PC350	320
110PC375	344
110PC430	400
110PC500	470
Special widths	F= C-85

Chain Type	F2 mm
110PC150	112
110PC175	137
110PC200	162
110PC225	187
110PC250	212
110PC275	237
110PC300	262
110PC325	287
110PC350	312
110PC375	336
110PC430	392
110PC500	462
Special widths	F= C-93

Bright Zinc Plated Steel Type Part Number

Complete Set Assembled	Part Number
Chain type	End Brackets Set
110PC A110PC □□□ KM □**	

Complete Set Unassembled	Part Number
Chain type	End Brackets Set
110PC A110PC □□□ K □**	

Available on request in stainless steel.
** 1=Pos.1; 2=Pos.2; 3=Pos.3
See mounting variations page 31

Tiewrap Clamp kit mounted on female attachment

Part Number
Assembled SFCT110□□□*FKM
Unassembled SFCT110□□□*FK
* Inner width (C)

Tiewrap Clamp kit mounted on male attachment

Part Number
Assembled SFCT110□□□*MKM
Unassembled SFCT110□□□*MK
* Inner width (C)

Serie Protection

H110PC

Nylon chain with opening aluminium covers

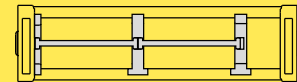

Separation System To choose the separators see page 216



How to open the covers



Easy opening of the pin junction.

Allen key for the opening of the pin



Suitable to long travel distance. See page 184

For further information please consult Brevetti Stendalto's Technical Office



Serie Protection

325PI Nylon Cable Chain with opening frames

Inner height (D) 25 mm

Single link construction with central large anti-friction pivot, for high torsion and tensile resistance.

Frames opening from inner radius.

Vertical separators available.

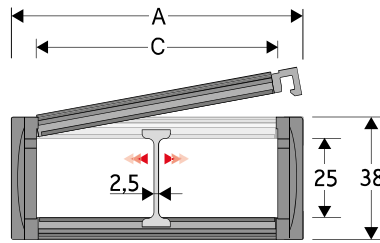

Separator

- Unassembled	Part.no S325L
- Assembled	Part.no S325LMC

Technical characteristics when self-supported

Speed	10 m/s
Acceleration	50 m/s ²

For higher requirements please consult our technical dept.

A	B	C	D	R	Weight/m	Chain
mm	mm	mm	mm	mm	kg	Part Number
57	38	40	25	075-100-125-150	1,15	325PI040 □□□ *
77	38	60	25	075-100-125-150	1,30	325PI060 □□□ *
93	38	76	25	075-100-125-150	1,40	325PI076 □□□ *
120	38	103	25	075-100-125-150	1,70	325PI103 □□□ *

*Complete the code by inserting the value of the radius (R): Ex. 325PI040 □□□□□

4

For sliding applications, technical data can slightly change according to frequency, added weight and environment.

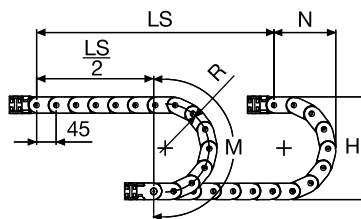

R	H	N	M	N1	M1
mm	mm	mm	mm	mm	mm
075	188	140	325	185	420
100	238	165	405	275	635
125	288	190	485	360	855
150	338	215	565	445	1075

SLIDING VERSION
to be ordered with pivoting
end brackets set

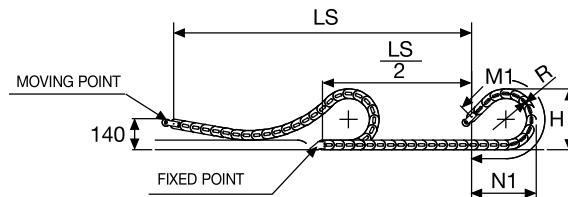

Length of chain (L)

Half travel distance ($\frac{LS}{2}$)
plus length of curve (M) or (M1)

$$L = \frac{LS}{2} + M \text{ or } M1$$

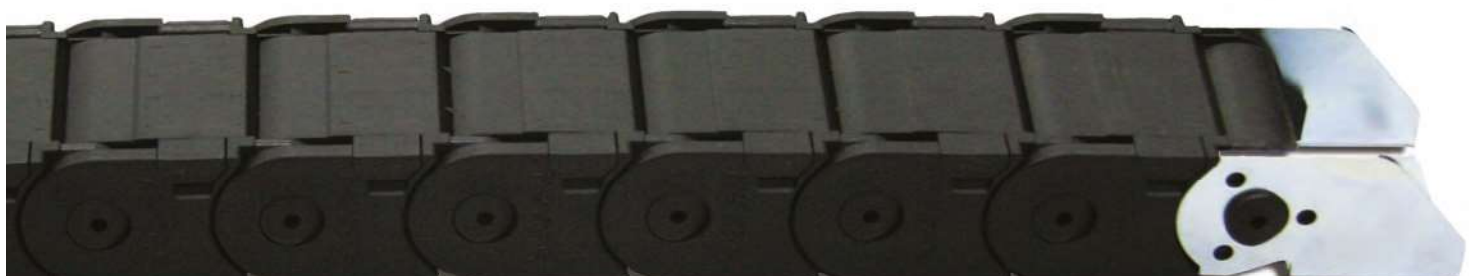

Serie Protection

325PI

Nylon Cable Chain
with opening frames

Self-Supporting Capacity Diagram

The maximum length of the self-supporting capacity ($\frac{LS}{2}$) in relationship to the weight of the cables and hoses contained per linear metre.

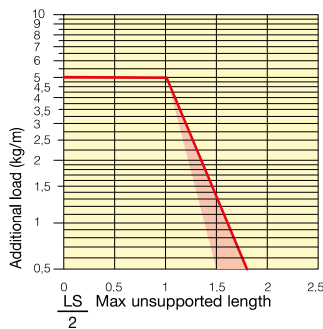

End Brackets

The end brackets set allows the two ends of the chain to be attached to the equipment. Set complete with tie-wrap clamps available on request.

Nylon Type

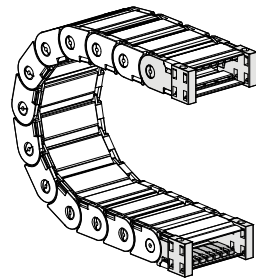

Fig. A
Chain fixed outside/inside the radius. (Fig A)

Bright Zinc Plated Steel Type***

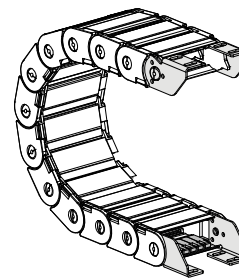
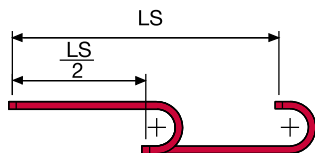
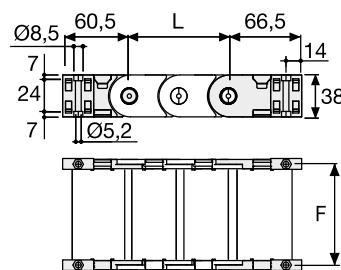

Fig. B
Chain fixed outside or inside the radius. (Fig B)



The red marking in the diagram area considers the difference of weight between various widths of chain.

For applications with $\frac{LS}{2}$ and weights not included in the area of the diagram showing self-supporting capacity, verify the possible use of support rollers (see page 30).



Chain Type	F mm
325PI...040	51
325PI...060	71
325PI...076	87
325PI...103	114

Nylon Type Part Numbers

Complete Set Assembled Chain Type	End Brackets Set
325PI...	AN325P□□□*KM

Complete Set Unassembled Chain Type	End Brackets Set
325PI...	AN325P□□□*K

Tiewrap Clamp Part Number
Assembled CFC325L □□□*KM
Unassembled CFC325L □□□*K

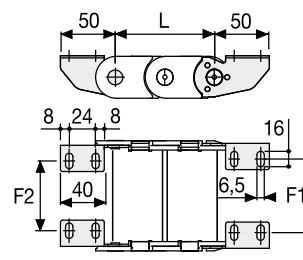

Chain Type	F2 mm	F1 mm
325PI...040	22	25,5
325PI...060	42	45,5
325PI...076	58	61,5
325PI...103	85	88,5

Bright Zinc Plated Steel Type Part Numbers

Complete Set Assembled Chain Type	End Brackets Set
325PI...	A325LK

Tiewrap Clamp Part Number
Assembled CFC325L □□□*KM
Unassembled CFC325L □□□*K

* Inner width (C)
***Available on request in stainless steel

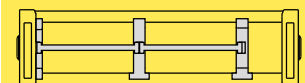

Separation System To choose the separators see page 216



Suitable to long travel distance in frame every pitch version. To choose the guide channel see page 58

For further information please consult Brevetti Stendalto's Technical Office

Serie Protection

335PS

Nylon cable chain with nylon cover openable to snap

Inner height (D) 35 mm

The chain has single link. Nylon cover is opened only on inner radius. Supplementary movable separators.

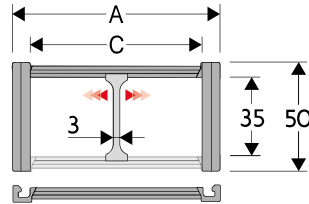

Separator

- Unassembled	Part. no S4353
- Assembled	Part. no S4353MC

Technical characteristics when self-supported

Speed	10 m/s
acceleration	50 m/s ²

For higher requirements please consult our technical dept.

A	B	C	D	R	Weight/m	Chain
mm	mm	mm	mm	mm	kg	Part Number
66,5	50	50	35	100-125-150-200	1,35	335PS050 □□□ *
92,5	50	76	35	100-125-150-200	1,57	335PS076 □□□ *
119,5	50	103	35	100-125-150-200	1,81	335PS103 □□□ *
166,5	50	150	35	100-125-150-200	2,21	335PS150 □□□ *

*Complete the code by inserting the value of the radius (R): Ex. 335PS050 □ □ □ □

4

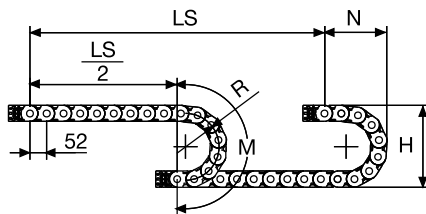

R	H	N	M	N1	M1
mm	mm	mm	mm	mm	mm
100	250	204	420	350	790
125	300	229	500	445	1025
150	350	254	580	540	1260
200	450	304	735	730	1725

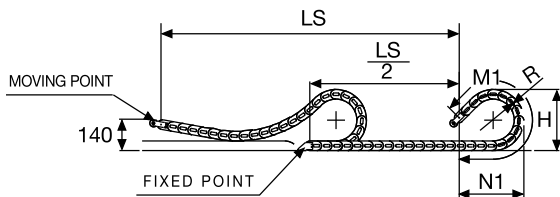

SLIDING VERSION
to be ordered with pivoting
end brackets set

Length of chain (L)
Half travel distance ($\frac{LS}{2}$)
plus length of curve (M) or (M1)

$$L = \frac{LS}{2} + M \text{ or } M1$$

For sliding applications, characteristics techniques may vary depending on the frequency, added weight and work environment.



Serie Protection

335PS
Nylon cable chain
with nylon cover
openable to snap

Self-Supporting Capacity Diagram

The maximum length of the self-supporting capacity ($\frac{LS}{2}$) in relationship to the weight of the cables and hoses contained per linear metre.

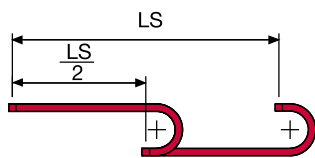
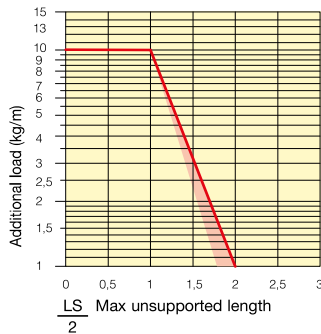

The red marking in the diagram area considers the difference of weight between various widths of chain.

For applications with $\frac{LS}{2}$ and weights not included in the area of the diagram showing self-supporting capacity, verify the possible use of support rollers (see page 30).

End Brackets

The end brackets set allows the two ends of the chain to be attached to the equipment. Set complete with tie-wrap clamps available on request.

Nylon Type

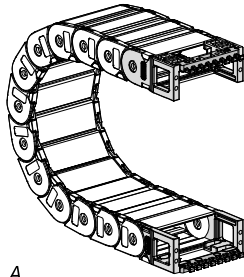
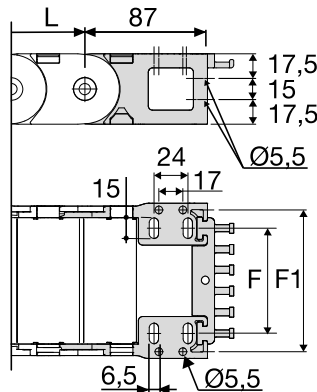

Fig. A
The chain can be fixed frontally, inner or outer radius. (Fig A)



Chain type	F mm	F1 mm
335P...050	35	61
335P...076	61	87
335P...103	88	114
335P...150	135	161

Nylon Type Part Numbers

Complete Set Assembled Chain Type	End Brackets Set
335	AN335P□□□*KM□**

Complete Set Unassembled Chain Type	End Brackets Set
335	AN335P□□□*K

Tiewrap Clamp	Part Number
335	PFN335□□□*

* Inner width (C)
** 1=Pos.1; 2=Pos.2; 3=Pos.3



435PU

Nylon Protection Cable Chain with opening covers

Inner height (D) 35 mm

Sideband & Frame construction with large anti-friction single-pin. Vertical separators are available.

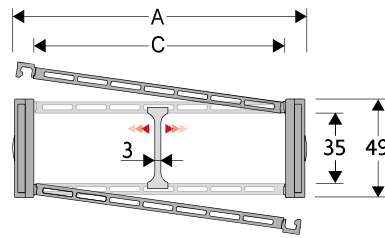

Separator

- Unassembled	Part.no S4353
- Assembled*	Part.no S4353MCI
- Assembled**	Part.no S4353MCE

Pin

Part.no PG4353

* for chain opening outer radius
** for chain opening inner radius

Technical characteristics when self-supported

Speed	10 m/s
Acceleration	50 m/s ²

For higher requirements please consult our technical dept.

A	B	C	D	R	Weight/m	Chain
mm	mm	mm	mm	mm	kg	Part Number
60	49	40	35	075-100-125-150-200	1,25	435PU040 □□□ *
70	49	50	35	075-100-125-150-200	1,40	435PU050 □□□ *
80	49	60	35	075-100-125-150-200	1,45	435PU060 □□□ *
96	49	76	35	075-100-125-150-200	1,60	435PU076 □□□ *
117	49	97	35	075-100-125-150-200	1,75	435PU097 □□□ *
123	49	103	35	075-100-125-150-200	1,90	435PU103 □□□ *
145	49	125	35	075-100-125-150-200	2,10	435PU125 □□□ *
170	49	150	35	075-100-125-150-200	2,35	435PU150 □□□ *

*Complete the code by inserting the value of the radius (R): Ex. 435PU040 □□□□

4

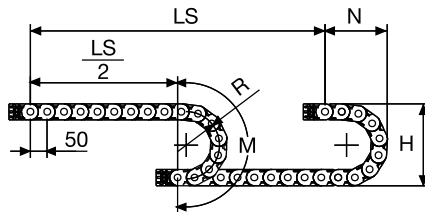

Length of chain (L)

Half travel distance ($\frac{LS}{2}$)
plus length of curve (M)

$$L = \frac{LS}{2} + M$$

R	H	N	M
mm	mm	mm	mm
075	199	155	340
100	249	175	415
125	299	200	495
150	349	230	575
200	449	275	730



Serie Protection

435PU
Nylon Protection
Cable Chain with
opening covers

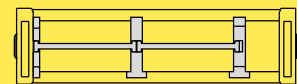

Separation System To
choose the separators see
page 216

Bright Zinc Plated
Steel Type***

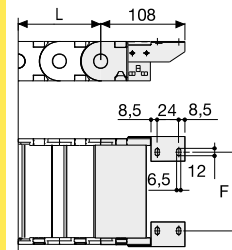
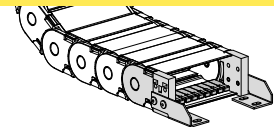

F = A-30

Bright Zinc Plated Steel
Type Part Numbers

Complete Set Assembled

A435P□□□*KM□**

Complete Set Unassembled

A435P□□□*K□**

Tiewrap Clamp
Part Number

Complete Set Assembled

CFC435M□□□*KM

Complete Set Unassembled

CFC435M□□□*K

* Inner width (C)

** 1=Pos.1; 2=Pos.2; 3=Pos.3

*** Available on request in stainless steel

**Self-Supporting
Capacity Diagram**

The maximum length of the self-supporting capacity ($\frac{LS}{2}$) in relationship to the weight of the cables and hoses contained per linear metre.

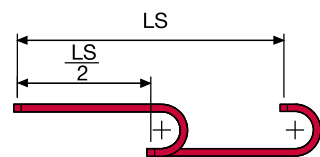
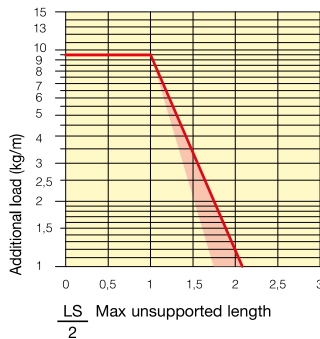

The red marking in the diagram area considers the difference of weight between various widths of chain.

For applications with $\frac{LS}{2}$ and weights not included in the area of the diagram showing self-supporting capacity, verify the possible use of support rollers (see page 30).

End Brackets

The end brackets set allows the two ends of the chain to be attached to the equipment. Set complete with tie-wrap clamps available on request.

Nylon Type

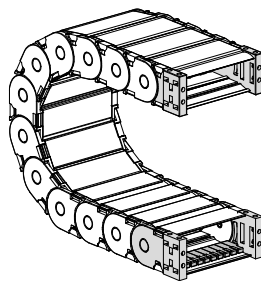
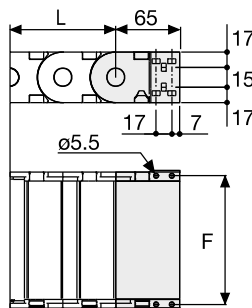

Fig. A
The chain can be fixed frontally,
inner or outer radius. (Fig A)



Chain Type	F mm
435PU040	51
435PU050	61
435PU060	71
435PU076	87
435PU097	108
435PU103	114
435PU125	136
435PU150	161

**Nylon Type
Part Numbers**

Complete Set Assembled

AN435P□□□*KM

Complete Set Unassembled

AN435P□□□*K

**Tiewrap Clamp
Part Number**

Complete Set Assembled

CFC435M□□□*KM

Complete Set Unassembled

CFC435M□□□*K

Nylon Type

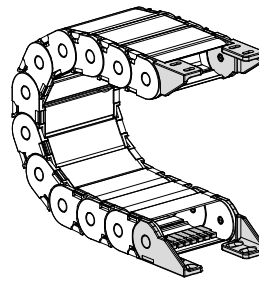
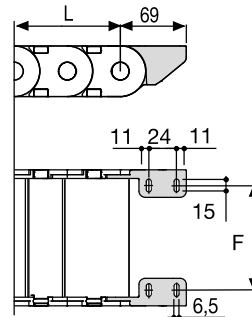

Fig. B
Chain fixed outside the radius. (Fig B)
See end brackets mounting
variations page 31



Chain Type	F mm
435PU040	26,5
435PU050	36,5
435PU060	46,5
435PU076	62,5
435PU097	83,5
435PU103	89,5
435PU125	111,5
435PU150	136,5

**Nylon Type
Part Numbers**

Complete Set Assembled

AN435KM□****

Complete Set Unassembled

AN435K□****

**Tiewrap Clamp
Part Number**

Complete Set Assembled

CFC435M□□□*KM

Complete Set Unassembled

CFC435M□□□*K

****1=Pos.1; 2=Pos.2; 3=Pos.3

5=Pos.5; 6=Pos.6



445PU

Nylon Protection Cable Chain with opening covers

Inner height (D) 45 mm

Sideband & Frame construction with large anti-friction single-pin.

Vertical separators are available.

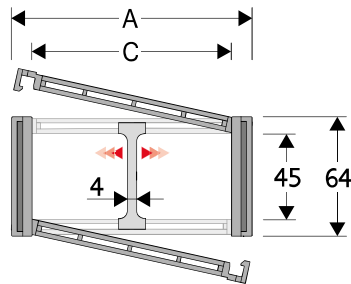

Separator

- Unassembled	Part.no S445UF
- Assembled*	Part.no S445UFMCI
- Assembled**	Part.no S445UFMCE

Pin

Part.no PG445

* for chain opening outer radius
** for chain opening inner radius

Technical characteristics when self-supported

Speed	10 m/s
Acceleration	50 m/s ²

For higher requirements please consult our technical dept.

A	B	C	D	R	Weight/m	Chain
mm	mm	mm	mm	mm	kg	Part Number
72	64	50	45	100-125-150-175-200-250-300	1,83	445PU050 □□□ *
83	64	61	45	100-125-150-175-200-250-300	1,87	445PU061 □□□ *
97	64	75	45	100-125-150-175-200-250-300	2,05	445PU075 □□□ *
103	64	81	45	100-125-150-175-200-250-300	2,10	445PU081 □□□ *
107	64	85	45	100-125-150-175-200-250-300	2,15	445PU085 □□□ *
117	64	95	45	100-125-150-175-200-250-300	2,23	445PU095 □□□ *
122	64	100	45	100-125-150-175-200-250-300	2,26	445PU100 □□□ *
129	64	107	45	100-125-150-175-200-250-300	2,31	445PU107 □□□ *
139	64	117	45	100-125-150-175-200-250-300	2,38	445PU117 □□□ *
147	64	125	45	100-125-150-175-200-250-300	2,49	445PU125 □□□ *
158	64	136	45	100-125-150-175-200-250-300	2,60	445PU136 □□□ *
172	64	150	45	100-125-150-175-200-250-300	2,71	445PU150 □□□ *
197	64	175	45	100-125-150-175-200-250-300	2,93	445PU175 □□□ *
222	64	200	45	100-125-150-175-200-250-300	3,17	445PU200 □□□ *
233	64	211	45	100-125-150-175-200-250-300	3,26	445PU211 □□□ *
247	64	225	45	100-125-150-175-200-250-300	3,39	445PU225 □□□ *
274	64	252	45	100-125-150-175-200-250-300	3,64	445PU252 □□□ *
283	64	261	45	100-125-150-175-200-250-300	3,71	445PU261 □□□ *
308	64	286	45	100-125-150-175-200-250-300	3,92	445PU286 □□□ *
334	64	312	45	100-125-150-175-200-250-300	4,13	445PU312 □□□ *
356	64	334	45	100-125-150-175-200-250-300	4,35	445PU334 □□□ *
384	64	362	45	100-125-150-175-200-250-300	4,59	445PU362 □□□ *

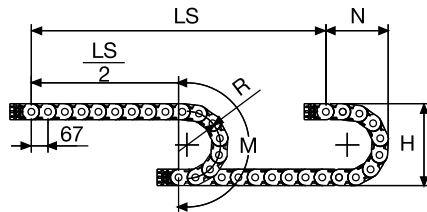

Length of chain (L)

Half travel distance ($\frac{LS}{2}$) plus length of curve (M)

$$L = \frac{LS}{2} + M$$

R	H	N	M
mm	mm	mm	mm
100	264	200	450
125	314	225	530
150	364	250	605
175	414	275	685
200	464	300	765
250	564	350	920
300	664	400	1080

*Complete the code by inserting the value of the radius (R): Ex. 445PU050 □□□ □



Serie Protection

445PU

Nylon Protection Cable Chain with opening covers

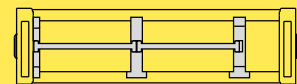

Separation System To choose the separators see page 216

Bright Zinc Plated Steel Type***

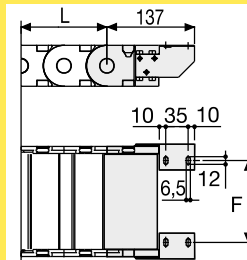
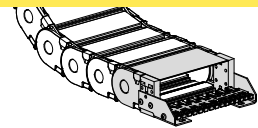

$F = A - 44$

Bright Zinc Plated Steel Type Part Numbers

Complete Set Assembled

A445P□□□*KM□**

Complete Set Unassembled

A445P□□□*K□**

* Inner width (C)

** 1=Pos.1; 2=Pos.2; 3=Pos.3

*** Available on request in stainless steel

For further information please consult Brevetti Stendalto's Technical Office

Self-Supporting Capacity Diagram

The maximum length of the self-supporting capacity ($\frac{LS}{2}$) in relationship to the weight of the cables and hoses contained per linear metre.

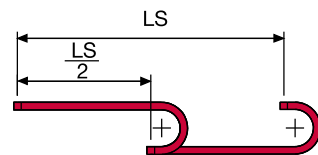
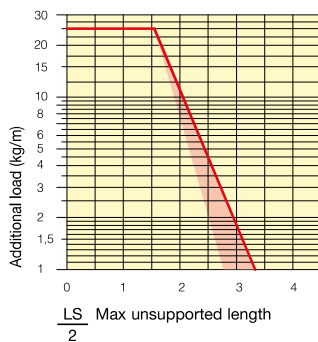

The red marking in the diagram area considers the difference of weight between various widths of chain.

For applications with $\frac{LS}{2}$ and weights not included in the area of the diagram showing self-supporting capacity, verify the possible use of support rollers (see page 30).

End Brackets

The end brackets set allows the two ends of the chain to be attached to the equipment. Set complete with tie-wrap clamps available on request.

Nylon Type

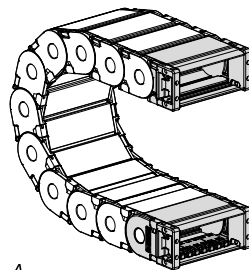
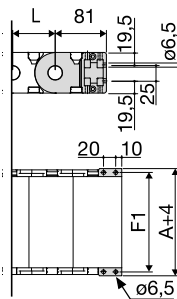

Fig. A The chain can be fixed frontally, inner or outer radius. (Fig A)



Chain Type	F mm
445PU050	63
445PU061	74
445PU075	88
445PU081	94
445PU085	98
445PU095	108
445PU100	113
445PU107	120
445PU117	130
445PU125	138
445PU136	149
445PU150	163
445PU175	188
445PU200	213
445PU211	224
445PU225	238
445PU252	265
445PU261	274
445PU286	289
445PU312	325
445PU334	347
445PU362	375

Nylon Type Part Numbers

Complete Set Assembled
AW445P□□□*KM

Complete Set Unassembled
AW445P□□□*K

Tiewrap Clamp Part Numbers

Complete Set Assembled
CFC445M□□□*KM

Complete Set Unassembled
CFC445M□□□*K

Nylon Type

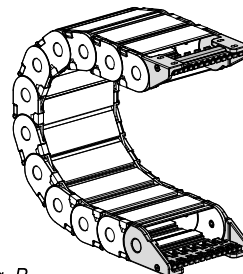
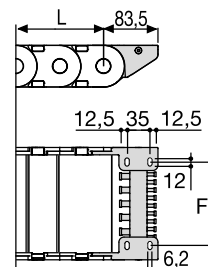

Fig. B Chain fixed outside the radius. (Fig B) See end brackets mounting variations page 31.



Chain Type	F mm
445PU050	28
445PU061	39
445PU075	53
445PU081	59
445PU085	63
445PU095	73
445PU100	78
445PU107	85
445PU117	95
445PU125	103
445PU136	114
445PU150	128
445PU175	153
445PU200	178
445PU211	189
445PU225	203
445PU252	230
445PU261	239
445PU286	254
445PU312	290
445PU334	312
445PU362	340

Nylon Type Part Numbers

Complete Set Assembled
AN445KM□□**

Complete Set Unassembled
AN445K□□**

Tiewrap Clamp Part Numbers

Complete Set Assembled
SFCT445□□□*KM

Complete Set Unassembled
SFCT445□□□*K

**1=Pos.1; 2=Pos.2; 3=Pos.3



445PS Nylon Protection Cable Chain with opening covers

Inner height (D) 41 mm

Sideband construction with anti-friction sigle-pin.

Covers openable only inner radius.
Vertical separator system are available.

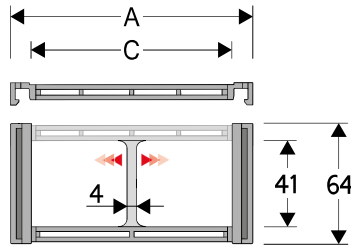

Separator

- Unassembled	Part.no S445CNF
- Assembled	Part.no S445CNFMC

Pin

Part.no PG445

Technical characteristics when self-supported

Speed	10 m/s
Acceleration	50 m/s ²

For higher requirements please consult our technical dept.

A	B	C	D	R	Weight/m	Chain
mm	mm	mm	mm	mm	kg	Part Number
83	64	61	41	100-125-150-175-200-250-300	1,87	445PS061 □□□ *
97	64	75	41	100-125-150-175-200-250-300	2,05	445PS075 □□□ *
147	64	125	41	100-125-150-175-200-250-300	2,49	445PS125 □□□ *

*Complete the code by inserting the value of the radius (R): Ex. Es. 445PS061 □□□ □

4

For sliding applications, characteristics techniques may vary depending on the frequency, added weight and work environment.

R	H	N	M	N1	M1
mm	mm	mm	mm	mm	mm
100	264	200	450	340	740
125	314	225	530	460	1020
150	364	250	605	580	1300
175	414	275	685	700	1575
200	464	300	765	820	1855
250	564	350	920	1055	2410
300	664	400	1080	1295	2970

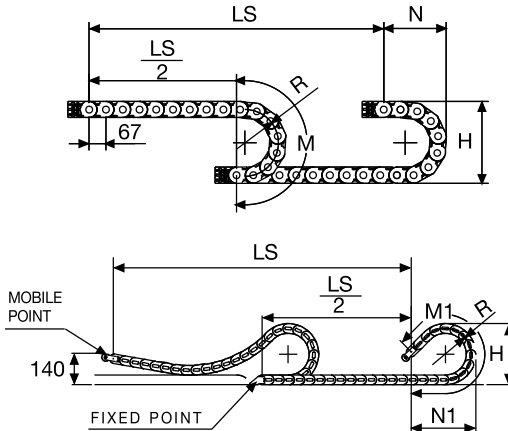

SLIDING VERSION
to be ordered with pivoting
end brackets set

Length of chain (L)

Half travel distance ($\frac{LS}{2}$)

plus length of curve (M) or (M1)

$$L = \frac{LS}{2} + M \text{ or } M1$$



Self-Supporting Capacity Diagram

The maximum length of the self-supporting capacity ($\frac{LS}{2}$) in relationship to the weight of the cables and hoses contained per linear metre.

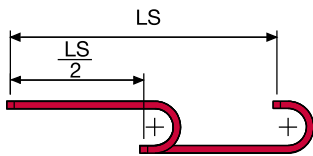
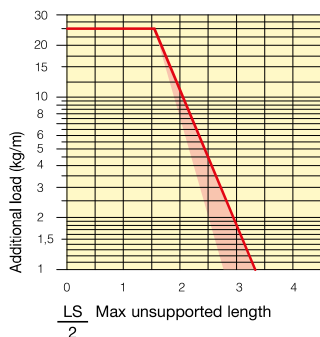

The red marking in the diagram area considers the difference of weight between various widths of chain.

For applications with $\frac{LS}{2}$ and weights not included in the area of the diagram showing self-supporting capacity, verify the possible use of support rollers (see page 30).

END-BRACKETS for SLIDING



Nylon Type Part Numbers

Complete Set Assembled	AWB445PS□□□*KM□**
Complete Set Unassembled	AWB445PS□□□*K

* Inner width (C)
** 1=Pos.1; 2=Pos.2

End Brackets

The end brackets set allows the two ends of the chain to be attached to the equipment. Set complete with tie-wrap clamps available on request.

Nylon version

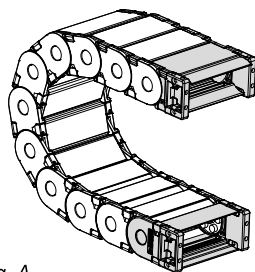
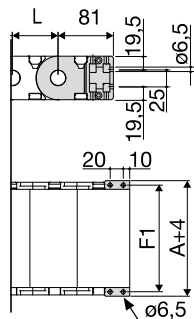

Fig. A
The chain can be fixed frontally, inner or outer radius. (Fig A)



Chain type	F mm
445PS 061	74
445PS 075	88
445PS 125	138

Nylon Type Part Numbers

Complete Set Assembled	AW445PS□□□*KM
Complete Set Unassembled	AW445PS□□□*K
* Inner width (C)	

Nylon version

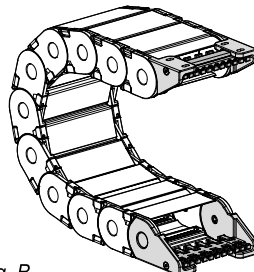
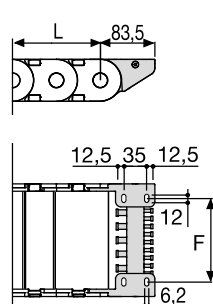

Fig. B
Chain fixed outside the radius. (Fig B)
See end brackets mounting variations page 31.



Chain type	F mm
445PS 061	39
445PS 075	53
445PS 125	103

Nylon Type Part Numbers

Complete Set Assembled	AN445PSKM□**
Complete Set Unassembled	AN445PSK (for pos. 1,2,3)
	AN445PSK□*** (for pos. 5,6)

Tiewrap Clamp Part Number

Complete Set Assembled	SFCT445□□□*KM
Complete Set Unassembled	SFCT445□□□*K
* Inner width (C)	
** 1=Pos.1; 2=Pos.2; 3=Pos.3	
5=Pos.5; 6=Pos.6	
*** 5=Pos.5; 6=Pos.6	

Serie Protection

445PS Nylon Protection Cable Chain with opening covers



S445CNF

This separator can be mounted in 2 ways different ensuring the same reliable resistance.

MOBILE separator



mounted outside the premises the separator can move

FIXED Separator



mounted inside the seats assumes a fixed position.

For further information please consult Brevetti Stendalto's Technical Office



445AU

Nylon Protection Cable Chain with opening aluminium covers

Inner height (D) 45 mm

Sideband & Frame construction with large anti-friction single-pin.

Vertical separators are available.

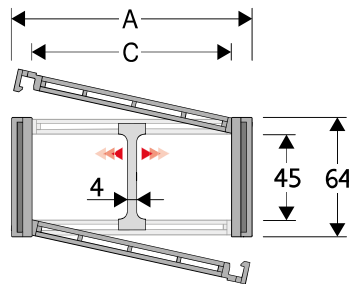

Separator

- Unassembled	Part.no S445UF
- Assembled*	Part.no S445UFMCI
- Assembled**	Part.no S445UFMCE

Pin

Part.no PG445

* for chain opening outer radius
** for chain opening inner radius

Technical characteristics when self-supported

Speed	10 m/s
Acceleration	50 m/s ²

For higher requirements please consult our technical dept.

A	B	C	D	R	Weight/m	Chain
mm	mm	mm	mm	mm	kg	Part Number
72	64	50	45	100-125-150-175-200-250-300	2,13	445AU050 □□□ *
83	64	61	45	100-125-150-175-200-250-300	2,24	445AU061 □□□ *
97	64	75	45	100-125-150-175-200-250-300	2,49	445AU075 □□□ *
103	64	81	45	100-125-150-175-200-250-300	2,59	445AU081 □□□ *
107	64	85	45	100-125-150-175-200-250-300	2,65	445AU085 □□□ *
117	64	95	45	100-125-150-175-200-250-300	2,79	445AU095 □□□ *
122	64	100	45	100-125-150-175-200-250-300	2,85	445AU100 □□□ *
129	64	107	45	100-125-150-175-200-250-300	2,95	445AU107 □□□ *
139	64	117	45	100-125-150-175-200-250-300	3,08	445AU117 □□□ *
147	64	125	45	100-125-150-175-200-250-300	3,24	445AU125 □□□ *
158	64	136	45	100-125-150-175-200-250-300	3,41	445AU136 □□□ *
172	64	150	45	100-125-150-175-200-250-300	3,61	445AU150 □□□ *
197	64	175	45	100-125-150-175-200-250-300	3,97	445AU175 □□□ *
222	64	200	45	100-125-150-175-200-250-300	4,35	445AU200 □□□ *
233	64	211	45	100-125-150-175-200-250-300	4,51	445AU211 □□□ *
247	64	225	45	100-125-150-175-200-250-300	4,73	445AU225 □□□ *
274	64	252	45	100-125-150-175-200-250-300	5,13	445AU252 □□□ *
283	64	261	45	100-125-150-175-200-250-300	5,26	445AU261 □□□ *
308	64	286	45	100-125-150-175-200-250-300	5,63	445AU286 □□□ *
334	64	312	45	100-125-150-175-200-250-300	6,00	445AU312 □□□ *
356	64	334	45	100-125-150-175-200-250-300	6,33	445AU334 □□□ *
384	64	362	45	100-125-150-175-200-250-300	6,73	445AU362 □□□ *

*Complete the code by inserting the value of the radius (R): Ex. 445AU050 □□□ □

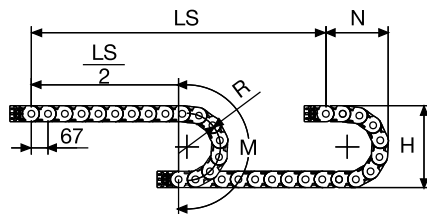

Length of chain (L)

Half travel distance ($\frac{LS}{2}$)
plus length of curve (M)

$$L = \frac{LS}{2} + M$$

R	H	N	M
mm	mm	mm	mm
100	264	200	450
125	314	225	530
150	364	250	605
175	414	275	685
200	464	300	765
250	564	350	920
300	664	400	1080



Serie Protection

445AU
Nylon Protection
Cable Chain with
opening aluminium
covers

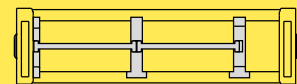

Separation System To
choose the separators see
page 216

Bright Zinc Plated
Steel Type***

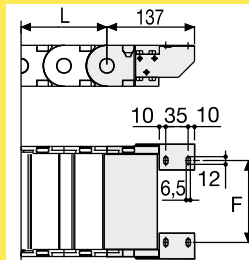
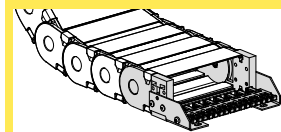

F = A-44

Bright Zinc Plated Steel
Type Part Numbers

Complete Set Assembled

A445A□□□*KM□**

Complete Set Unassembled

A445A□□□*K□**

* Inner width (C)

** 1=Pos.1; 2=Pos.2; 3=Pos.3

*** Available on request in stainless steel

For further information please
consult Brevetti Stendalto's
Technical Office

**Self-Supporting
Capacity Diagram**

The maximum length of the
self-supporting capacity ($\frac{LS}{2}$)
in relationship to the weight
of the cables and hoses
contained per linear metre.

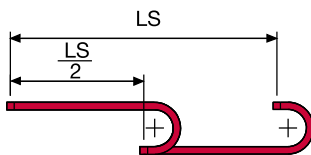
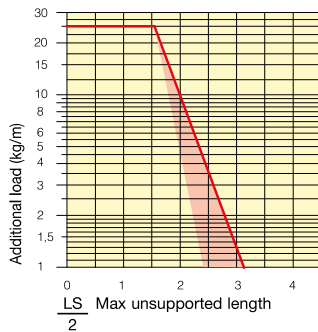

The red marking in the
diagram area considers the
difference of weight between
various widths of chain.

For applications with $\frac{LS}{2}$
and weights not included in
the area of the diagram
showing self-supporting
capacity, verify the possible
use of support rollers (see
page 30).

End Brackets

The end brackets set allows the two ends of the chain to be
attached to the equipment. Set complete with tie-wrap
clamps available on request.

Nylon Type

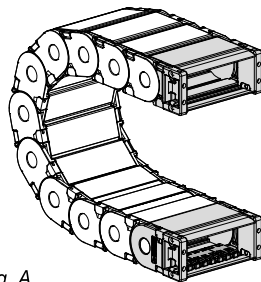
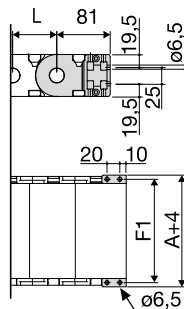

Fig. A
The chain can be fixed frontally,
inner or outer radius. (Fig A)



Chain Type	F mm
445AU050	63
445AU061	74
445AU075	88
445AU081	94
445AU085	98
445AU095	108
445AU100	113
445AU107	120
445AU117	130
445AU125	138
445AU136	149
445AU150	163
445AU175	188
445AU200	213
445AU211	224
445AU225	238
445AU252	265
445AU261	274
445AU286	299
445AU312	325
445AU334	347
445AU362	375

**Nylon Type
Part Numbers**

Complete Set Assembled

AW445A□□□*KM

Complete Set Unassembled

AW445A□□□*K

**Tiewrap Clamp
Part Numbers**

Complete Set Assembled

CFC445M□□□*KM

Complete Set Unassembled

CFC445M□□□*K

Nylon Type

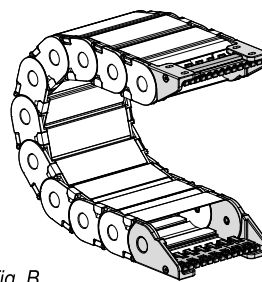
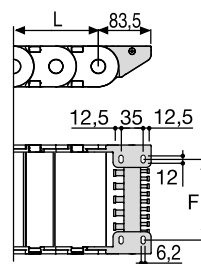

Fig. B
Chain fixed outside the radius. (Fig B)
See end brackets mounting
variations page 31.



Chain Type	F mm
445AU050	28
445AU061	39
445AU075	53
445AU081	59
445AU085	63
445AU095	73
445AU100	78
445AU107	85
445AU117	95
445AU125	103
445AU136	114
445AU150	128
445AU175	153
445AU200	178
445AU211	189
445AU225	203
445AU252	230
445AU261	239
445AU286	264
445AU312	290
445AU334	312
445AU362	340

**Nylon Type
Part Numbers**

Complete Set Assembled

AN445KM□**

Complete Set Unassembled

AN445K□**

**Tiewrap Clamp
Part Numbers**

Complete Set Assembled

SFCT445□□□*KM

Complete Set Unassembled

SFCT445□□□*K

**1=Pos.1; 2=Pos.2; 3=Pos.3



475PU

Nylon Protection Cable Chain with opening covers

Inner height (D) 75,5 mm

Sideband & Frame construction with large anti-friction single-pin. Vertical and horizontal modular separator system is available.

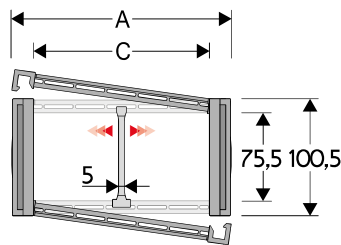

Separator

- Unassembled	Part.no S309S
- Assembled*	Part.no S309SMCI
- Assembled**	Part.no S309SMCE
Pin	Part.no PG475

* for chain opening outer radius
** for chain opening inner radius

Technical characteristics when self-supported

Speed	8 m/s
Acceleration	40 m/s ²

For higher requirements please consult our technical dept.

A	B	C	D	R	Weight/m	Chain
mm	mm	mm	mm	mm	kg	Part Number
112	100,5	74	75,5	180-200-250-300-350-400	4,60	475PU074 □□□ *
132	100,5	94	75,5	180-200-250-300-350-400	4,80	475PU094 □□□ *
157	100,5	119	75,5	180-200-250-300-350-400	5,10	475PU119 □□□ *
164	100,5	126	75,5	180-200-250-300-350-400	5,15	475PU126 □□□ *
187	100,5	149	75,5	180-200-250-300-350-400	5,40	475PU149 □□□ *
227	100,5	189	75,5	180-200-250-300-350-400	5,80	475PU189 □□□ *
262	100,5	224	75,5	180-200-250-300-350-400	6,20	475PU224 □□□ *
288	100,5	250	75,5	180-200-250-300-350-400	6,50	475PU250 □□□ *
312	100,5	274	75,5	180-200-250-300-350-400	6,75	475PU274 □□□ *
338	100,5	300	75,5	180-200-250-300-350-400	7,05	475PU300 □□□ *
362	100,5	324	75,5	180-200-250-300-350-400	7,30	475PU324 □□□ *
388	100,5	350	75,5	180-200-250-300-350-400	7,55	475PU350 □□□ *
412	100,5	374	75,5	180-200-250-300-350-400	7,85	475PU374 □□□ *
467	100,5	429	75,5	180-200-250-300-350-400	8,50	475PU429 □□□ *
536	100,5	498	75,5	180-200-250-300-350-400	9,20	475PU498 □□□ *

*Complete the code by inserting the value of the radius (R): Ex. 475PU119 1 15 00

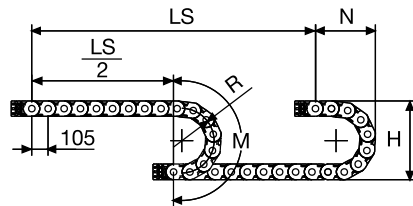

Length of chain (L)

Half travel distance ($\frac{LS}{2}$) plus length of curve (M)

$$L = \frac{LS}{2} + M$$

R	H	N	M
mm	mm	mm	mm
180	460,5	335	775
200	500,5	355	840
250	600,5	405	995
300	700,5	460	1155
350	800,5	505	1310
400	900,5	560	1470



Self-Supporting Capacity Diagram

The maximum length of the self-supporting capacity ($\frac{LS}{2}$) in relationship to the weight of the cables and hoses contained per linear metre.

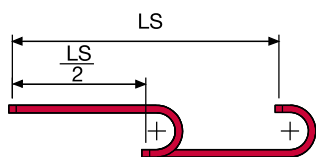
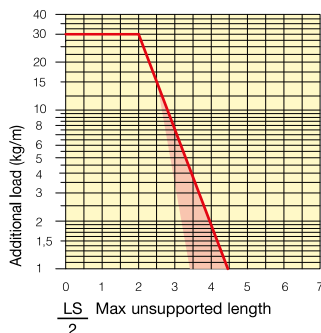

The red marking in the diagram area considers the difference of weight between various widths of chain.

For applications with $\frac{LS}{2}$ and weights not included in the area of the diagram showing self-supporting capacity, verify the possible use of support rollers (see page 30).

Bright Zinc Plated Steel End Brackets***

The end brackets set allows the two ends of the chain to be attached to the equipment.

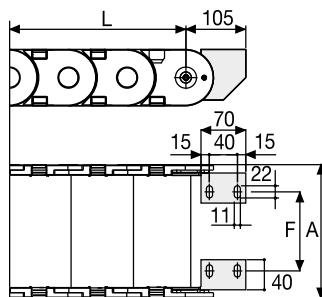
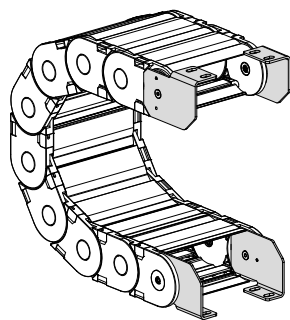

Fig. A
Chain fixed outside the radius. (Fig A)
See end brackets mounting variations page 31.

Chain Type	F mm
475PU074	35
475PU094	55
475PU119	80
475PU126	87
475PU149	110
475PU189	150
475PU224	185
475PU250	211
475PU274	235
475PU300	261
475PU324	285
475PU350	311
475PU374	335
475PU498	459

Bright Zinc Plated Steel Type Part Numbers

Complete Set Assembled Chain Type	End Brackets Set
475...	A475KM□**

Complete Set Unassembled Chain Type	End Brackets Set
475...	A475K

** 1=Pos.1; 2=Pos.2; 3=Pos.3
*** Available on request in stainless steel

Serie Protection

475PU Nylon Protection Cable Chain with opening covers

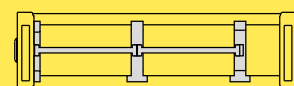

Separation System To choose the separators see page 216

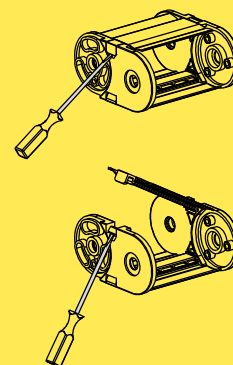

How to open the cover.



For further information please consult Brevetti Stendato's Technical Office

660 Nylon Protection Cable Chain with opening covers

Inner height (D) 36 mm

Double share Sideband & Frame construction with large anti-friction single-pin. Covers are opening from inner radius.

Vertical separators are available.

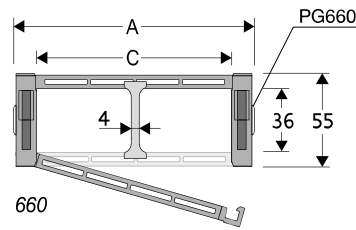

660

Separator

- Unassembled Part.no S660
- Assembled Part.no S660MC

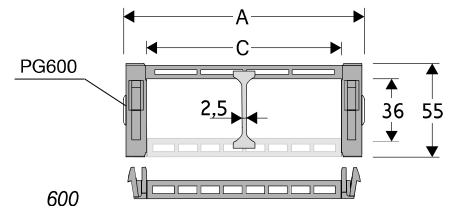

600

Separator

- Unassembled Part.no S600
- Assembled Part.no S600MC

Technical characteristics when self-supported

Speed	6 m/s
Acceleration	30 m/s ²

For higher requirements please consult our technical dept.

A	B	C	D	R	Weight/m	Chain
mm	mm	mm	mm	mm	kg	Part Number
79	55	50	36	100-150-200-250	1,90	660050 □□□ *
129	55	100	36	100-150-200-250	2,40	660100 □□□ *
179	55	150	36	100-150-200-250	3,00	60015 □ **

*Complete the code by inserting the value of the radius (R): Ex. 660050 □ □ □ □

**Complete the code by inserting the value of the radius (R): Ex. 60015 □

Where: 0=100; 1=150; 2=200; 3=250

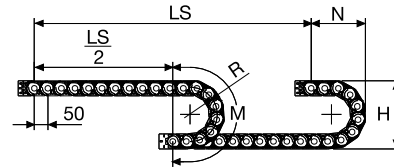

R	H	N	M
mm	mm	mm	mm
100	255	180	415
150	355	230	575
200	455	280	730
250	555	330	885

Length of chain (L)

Half travel distance ($\frac{LS}{2}$)

plus length of curve (M)

$$L = \frac{LS}{2} + M$$



Serie Protection

660

Nylon Protection Cable Chain with opening covers

How to open the cover.

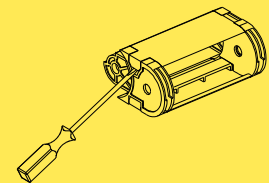
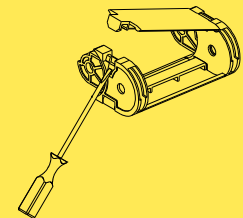

Special tool to remove the connecting pivots:
Part Number PZ010.



For further information please consult Brevetti Stendalto's Technical Office



Self-Supporting Capacity Diagram

The maximum length of the self-supporting capacity ($\frac{LS}{2}$) in relationship to the weight of the cables and hoses contained per linear metre.

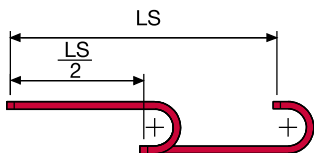
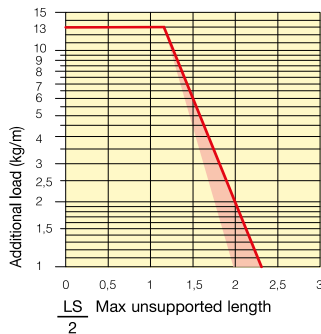

The red marking in the diagram area considers the difference of weight between various widths of chain.

For applications with $\frac{LS}{2}$ and weights not included in the area of the diagram showing self-supporting capacity, verify the possible use of support rollers (see page 30).

End Brackets

The end brackets set allows the two ends of the chain to be attached to the equipment.

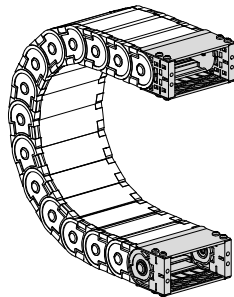
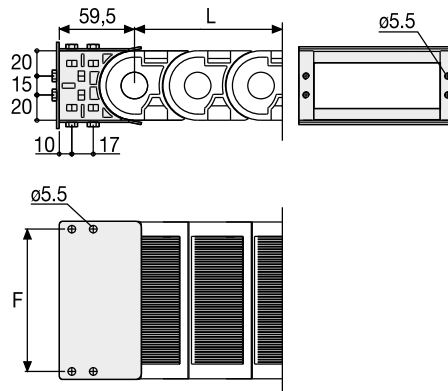

Fig. A
The chain can be fixed frontally, inner or outer radius. (Fig A)



Chain Type	F mm
660 C=50	62
660 C=100	112
600 C=150	162

Nylon Type Part Numbers

Complete Set Assembled	
Chain Type	End Brackets Set
660 C=50	AN660050KM
660 C=100	AN660100KM
600 C=150	AL600KM

Complete Set Unassembled	
Chain Type	End Brackets Set
660 C=50	AN660050K
660 C=100	AN660100K
600 C=150	AL600K

770 Nylon Protection Cable Chain with opening covers

Inner height (D) 51 mm

Double share Sideband & Frame construction with large anti-friction single-pin. Covers are opening from inner radius.

Vertical separators are available.

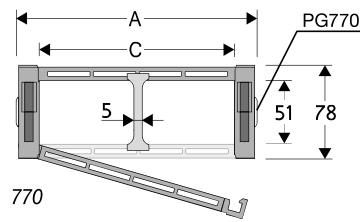

770

Separator

- Unassembled Part.no S770
- Assembled Part.no S770MC

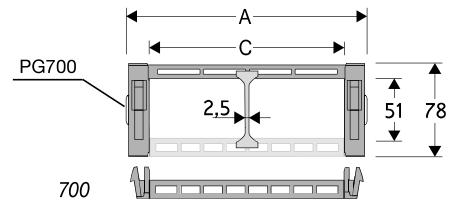

700

Separator

- Unassembled Part.no S700
- Assembled Part.no S700MC

Technical characteristics when self-supported

Speed	6 m/s
Acceleration	30 m/s ²

For higher requirements please consult our technical dept.

A	B	C	D	R	Weight/m	Chain
mm	mm	mm	mm	mm	kg	Part Number
120	78	85	51	150-200-250-300	3,30	770085 □□□ *
135	78	100	51	150-200-250-300	3,90	770100 □□□ *
185	78	150	51	150-200-250-300	4,10	770150 □□□ *
235	78	200	51	150-200-250-300	4,50	770200 □□□ *
285	78	250	51	150-200-250-300	5,00	70025 □ **

*Complete the code by inserting the value of the radius (R): Ex. 770085 □ □ □ □

**Complete the code by inserting the value of the radius (R): Ex. 70025 □

Where: 0=150; 1=200; 2=250; 3=300

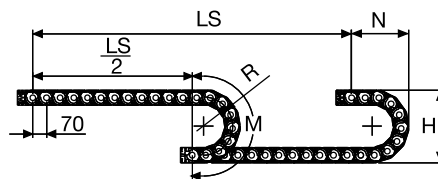

R	H	N	M
mm	mm	mm	mm
150	378	260	615
200	478	310	770
250	578	365	930
300	678	410	1085

Length of chain (L)

Half travel distance ($\frac{LS}{2}$)
plus length of curve (M)

$$L = \frac{LS}{2} + M$$



Serie Protection

770

Nylon Protection Cable Chain with opening covers

How to open the cover.

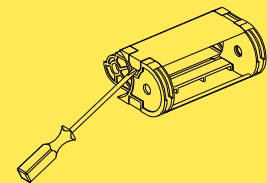
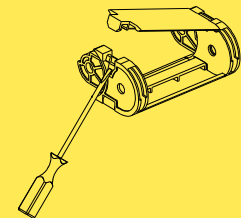

Special tool to remove the connecting pivots:
Part Number PZ010.



For further information please consult Brevetti Stendalto's Technical Office



Self-Supporting Capacity Diagram

The maximum length of the self-supporting capacity ($\frac{LS}{2}$) in relationship to the weight of the cables and hoses contained per linear metre.

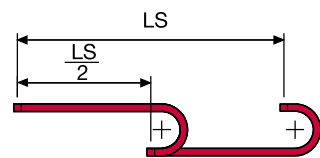
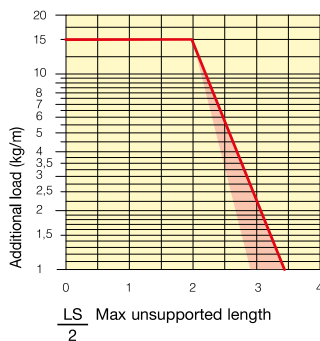

The red marking in the diagram area considers the difference of weight between various widths of chain.

For applications with $\frac{LS}{2}$ and weights not included in the area of the diagram showing self-supporting capacity, verify the possible use of support rollers (see page 30).

End Brackets

The end brackets set allows the two ends of the chain to be attached to the equipment.

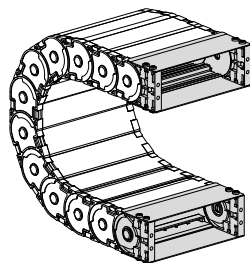
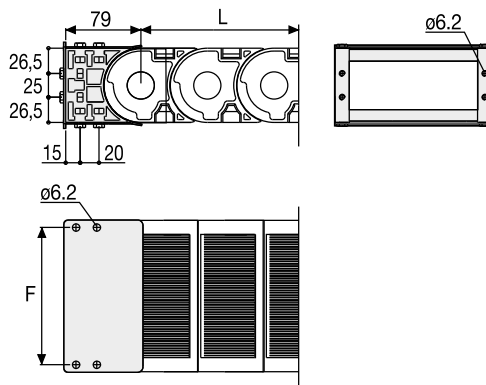

Fig. A
The chain can be fixed frontally, inner or outer radius. (Fig A)



Chain Type	F mm
770 C=85	100
770 C=100	115
770 C=150	165
770 C=200	215
700 C=250	265

Nylon Type Part Numbers

Complete Set Assembled	
Chain	End Brackets
Type	Set
770...	AN770□□□*KM
700 C=250	AL700KM

Complete Set Unassembled	
Chain	End Brackets
Type	Set
770...	AN770□□□*K
700 C=250	AL700K

* Inner width (C)

306CU

Nylon Protection Cable Chain with opening aluminium covers

Inner height (D) 37 mm

Strong double share Sideband & Frame construction with large anti-friction triple-pin.

Covers are opening from inner and outer radius.

Vertical separators are available.

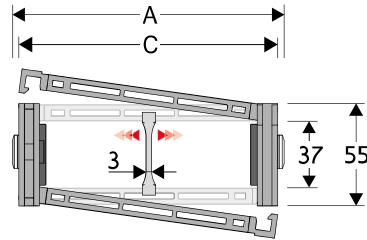

Separator

- Unassembled	Part.no S306SM
- Assembled	Part.no S306SMMC

Pin

Part.no PG309H

Technical characteristics when self-supported

Speed	8 m/s
Acceleration	40 m/s ²

For higher requirements please consult our technical dept.

A	B	C	D	R	Weight/m	Chain
mm	mm	mm	mm	mm	kg	Part Number
79	55	43	37	107-150-200-250-300	1,85	306CU043 □□□ *
90	55	54	37	107-150-200-250-300	1,90	306CU054 □□□ *
104	55	68	37	107-150-200-250-300	2,04	306CU068 □□□ *
110	55	74	37	107-150-200-250-300	2,09	306CU074 □□□ *
114	55	78	37	107-150-200-250-300	2,15	306CU078 □□□ *
124	55	88	37	107-150-200-250-300	2,20	306CU088 □□□ *
129	55	93	37	107-150-200-250-300	2,22	306CU093 □□□ *
136	55	100	37	107-150-200-250-300	2,27	306CU100 □□□ *
146	55	110	37	107-150-200-250-300	2,33	306CU110 □□□ *
154	55	118	37	107-150-200-250-300	2,42	306CU118 □□□ *
165	55	129	37	107-150-200-250-300	2,50	306CU129 □□□ *
179	55	143	37	107-150-200-250-300	2,61	306CU143 □□□ *
204	55	168	37	107-150-200-250-300	2,80	306CU168 □□□ *
229	55	193	37	107-150-200-250-300	3,00	306CU193 □□□ *
240	55	204	37	107-150-200-250-300	3,08	306CU204 □□□ *
254	55	218	37	107-150-200-250-300	3,19	306CU218 □□□ *
281	55	245	37	107-150-200-250-300	3,40	306CU245 □□□ *
290	55	254	37	107-150-200-250-300	3,47	306CU254 □□□ *
315	55	279	37	107-150-200-250-300	3,77	306CU279 □□□ *
341	55	305	37	107-150-200-250-300	3,84	306CU305 □□□ *
363	55	327	37	107-150-200-250-300	4,01	306CU327 □□□ *
391	55	355	37	107-150-200-250-300	4,22	306CU355 □□□ *

*Complete the code by inserting the value of the radius (R): Ex. 306CU110 □ □ □ □

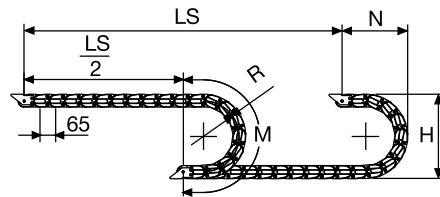

Length of chain (L)

Half travel distance ($\frac{LS}{2}$) plus length of curve (M)

$$L = \frac{LS}{2} + M$$

R	H	N	M
mm	mm	mm	mm
107	272	205	470
150	358	245	605
200	458	295	760
250	558	345	920
300	658	395	1075



Serie Protection

306CU

Nylon Protection Cable Chain with opening aluminium covers

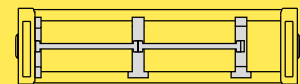

Separation System To choose the separators see page 216

Bright Zinc Plated Steel Type***

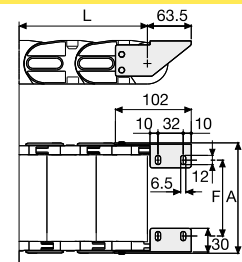
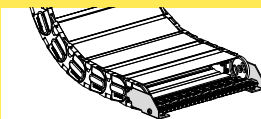

F = A-43

Bright Zinc Plated Steel Type Part Numbers

Complete Set Assembled Chain Type	End Brackets Set
306	A306CU□□□*KM□**
Complete Set Unassembled Chain Type	End Brackets Set
306	A306CU□□□*K□**
Tiewrap Clamp	
Assembl.	SFCT306S□□□ *KM
Unassembl.	SFCT306S□□□ *K

* Inner width (C)
** 1=Pos.1; 2=Pos.2; 3=Pos.3
*** Available on request in stainless steel

Self-Supporting Capacity Diagram

The maximum length of the self-supporting capacity ($\frac{LS}{2}$) in relationship to the weight of the cables and hoses contained per linear metre.

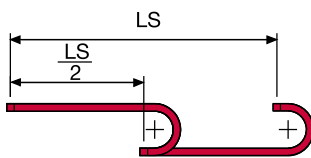
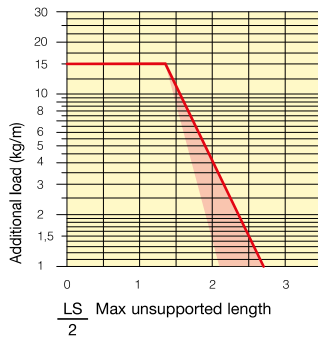

The red marking in the diagram area considers the difference of weight between various widths of chains assembled with nylon frames every second pitch.

For applications with $\frac{LS}{2}$ and weights not included in the area of the diagram showing self-supporting capacity, verify the possible use of support rollers (see page 30).

End Brackets

The end brackets set allows the two ends of the chain to be attached to the equipment. Set complete with tie-wrap clamps available on request.

Nylon Type

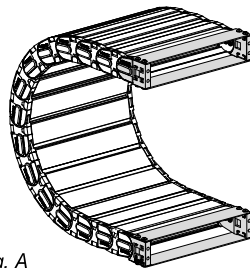
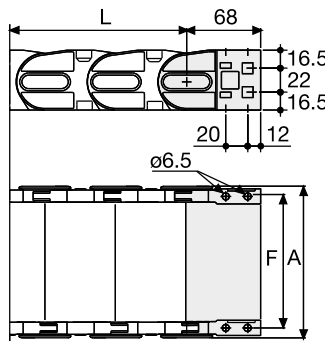

Fig. A The chain can be fixed frontally, inner or outer radius. (Fig A)



Chain Type	F mm
306CU043	61
306CU054	72
306CU068	86
306CU074	92
306CU078	96
306CU088	106
306CU093	111
306CU100	118
306CU110	128
306CU118	136
306CU129	147
306CU143	161
306CU168	186
306CU193	211
306CU204	222
306CU218	236
306CU245	263
306CU254	272
306CU279	297
306CU305	323
306CU327	345
306CU355	373

Nylon Type Part Numbers

Complete Set Assembled Chain Type	End Brackets Set
306	AN306C□□□*KM
Complete Set Unassembled Chain Type	End Brackets Set
306	AN306C□□□*K

Nylon Type

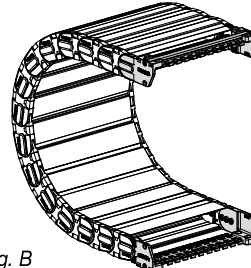
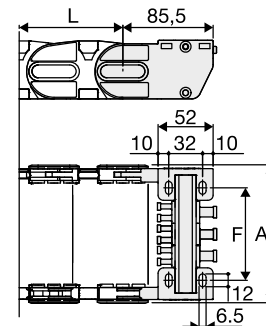

Fig. B Chain fixed outside the radius. (Fig B) See end brackets mounting variations page 31.



Chain Type	F mm
306CU043	36
306CU054	47
306CU068	61
306CU074	67
306CU078	71
306CU088	81
306CU093	86
306CU100	93
306CU110	103
306CU118	111
306CU129	122
306CU143	136
306CU168	161
306CU193	186
306CU204	197
306CU218	211
306CU245	238
306CU254	247
306CU279	272
306CU305	298
306CU327	320
306CU355	348

Nylon Type Part Numbers

Complete Set Assembled Chain Type	End Brackets Set
306	ANL306KM□□**
Complete Set Unassembled Chain Type	End Brackets Set
306	ANL306K□□**

Tiewrap Clamp
Assembl. SFCTL306□□□*KM
Unassembl. SFCTL306S□□□*K
SFCTL not applicable for C=43

308CU Nylon Protection Cable Chain with opening aluminium covers

Inner height (D) 57 mm

Strong double share Sideband & Frame construction with large anti-friction triple-pin.

Covers are opening from inner and outer radius.

Vertical separators are available.

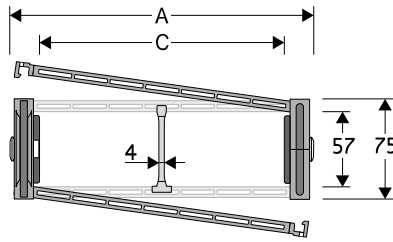

Separator

- Unassembled	Part.no S308C
- Assembled	Part.no S308CMCI for chain opening outer radius
- Assembled	Part.no S308CMCE for chain opening inner radius

Pin

Part.no PG308

Technical characteristics when self-supported

Speed	8 m/s
Acceleration	40 m/s ²

For higher requirements please consult our technical dept.

A	B	C	D	R	Weight/m	Chain
mm	mm	mm	mm	mm	kg	Part Number
82	75	38	57	150-180-200-230-280-300-400-600	2,90	308CU038 □□□ *
93	75	49	57	150-180-200-230-280-300-400-600	3,01	308CU049 □□□ *
107	75	63	57	150-180-200-230-280-300-400-600	3,19	308CU063 □□□ *
113	75	69	57	150-180-200-230-280-300-400-600	3,27	308CU069 □□□ *
117	75	73	57	150-180-200-230-280-300-400-600	3,35	308CU073 □□□ *
127	75	83	57	150-180-200-230-280-300-400-600	3,43	308CU083 □□□ *
132	75	88	57	150-180-200-230-280-300-400-600	3,48	308CU088 □□□ *
139	75	95	57	150-180-200-230-280-300-400-600	3,56	308CU095 □□□ *
149	75	105	57	150-180-200-230-280-300-400-600	3,67	308CU105 □□□ *
157	75	113	57	150-180-200-230-280-300-400-600	3,77	308CU113 □□□ *
168	75	124	57	150-180-200-230-280-300-400-600	3,91	308CU124 □□□ *
182	75	138	57	150-180-200-230-280-300-400-600	4,06	308CU138 □□□ *
207	75	163	57	150-180-200-230-280-300-400-600	4,36	308CU163 □□□ *
232	75	188	57	150-180-200-230-280-300-400-600	4,65	308CU188 □□□ *
243	75	199	57	150-180-200-230-280-300-400-600	4,78	308CU199 □□□ *
257	75	213	57	150-180-200-230-280-300-400-600	4,94	308CU213 □□□ *
284	75	240	57	150-180-200-230-280-300-400-600	5,25	308CU240 □□□ *
293	75	249	57	150-180-200-230-280-300-400-600	5,37	308CU249 □□□ *
318	75	274	57	150-180-200-230-280-300-400-600	5,48	308CU274 □□□ *
344	75	300	57	150-180-200-230-280-300-400-600	5,95	308CU300 □□□ *
366	75	322	57	150-180-200-230-280-300-400-600	6,20	308CU322 □□□ *
394	75	350	57	150-180-200-230-280-300-400-600	6,11	308CU350 □□□ *

*Complete the code by inserting the value of the radius (R): Ex. 308CU105 □ □ □

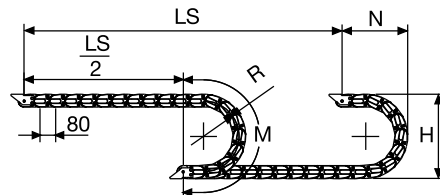

Length of chain (L)
Half travel distance ($\frac{LS}{2}$)
plus length of curve (M)

$$L = \frac{LS}{2} + M$$

R	H	N	M
mm	mm	mm	mm
150	375	270	635
180	435	300	725
200	475	320	790
230	535	350	885
280	635	400	1040
300	675	420	1105
400	875	520	1420
600	1275	750	2045



Serie Protection

308CU

Nylon Protection Cable Chain with opening aluminium covers

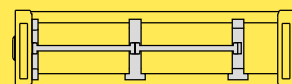

Separation System To choose the separators see page 216

Self-Supporting Capacity Diagram

The maximum length of the self-supporting capacity ($\frac{LS}{2}$) in relationship to the weight of the cables and hoses contained per linear metre.

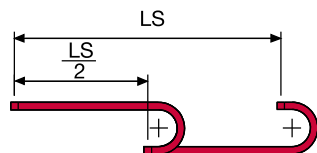
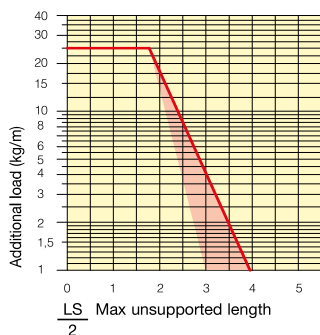

The red marking in the diagram area considers the difference of weight between various widths of chains assembled with nylon frames every second pitch.

For applications with $\frac{LS}{2}$ and weights not included in the area of the diagram showing self-supporting capacity, verify the possible use of support rollers (see page 30).

End Brackets

The end brackets set allows the two ends of the chain to be attached to the equipment. Set complete with tie-wrap clamps available on request.

Nylon Type

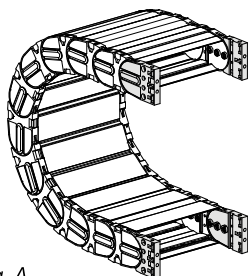
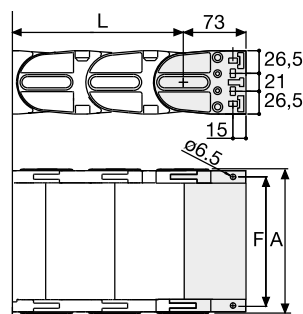

Fig. A The chain can be fixed frontally, inner or outer radius. (Fig A)



Chain Type	F mm
308CU038	62
308CU049	73
308CU063	87
308CU069	93
308CU073	97
308CU083	107
308CU088	112
308CU095	119
308CU105	129
308CU113	137
308CU124	148
308CU138	162
308CU163	187
308CU188	212
308CU199	223
308CU213	237
308CU240	264
308CU249	273
308CU274	298
308CU300	324
308CU322	346
308CU350	374

Nylon Type Part Numbers

Complete Set Assembled	
Chain	End Brackets
Type	Set
308	AN308C□□□*KM

Complete Set Unassembled	
Chain	End Brackets
Type	Set
308	AN308C□□□*K

Bright Zinc Plated Steel Type***

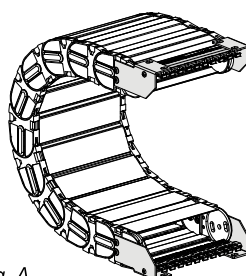
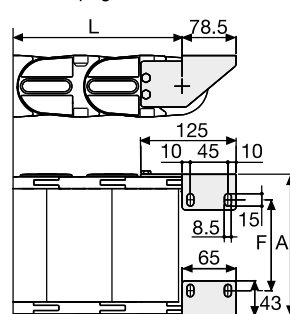

Fig. A Chain fixed outside the radius. (Fig A) See end brackets mounting variations page 31.



Chain Type	F mm
308CU038	-
308CU049	31
308CU063	45
308CU069	51
308CU073	55
308CU083	65
308CU088	70
308CU095	77
308CU105	87
308CU113	95
308CU124	106
308CU138	120
308CU163	145
308CU188	170
308CU199	181
308CU213	195
308CU240	222
308CU249	231
308CU274	256
308CU300	282
308CU322	304
308CU350	332

Bright Zinc Plated Steel Type Part Numbers

Complete Set Assembled	
Chain	End Brackets
Type	Set
308	A308CU□□□*KM□**

Complete Set Unassembled	
Chain	End Brackets
Type	Set
308	A308CU□□□*K□**

Tiewrap Clamp
 Assembl. SFCT308S □□□*KM
 Unassembl. SFCT308S □□□*K
 *** Inner width (C)

For further information please consult Brevetti Stendato's Technical Office



Serie Protection

309C Nylon Protection Cable Chain with opening covers

Inner height (D) 72 mm

Strong double share Sideband & Frame construction with large anti-friction triple-pin.
Covers are opening from outer radius
Vertical and horizontal separator systems are available.

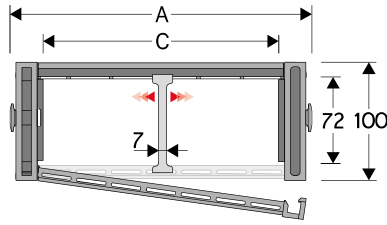

Separator

- Unassembled	Part.no S309PO
- Assembled	Part.no S309POMC

Pin

Part.no PG309

Technical characteristics when self-supported

Speed	8 m/s
Acceleration	40 m/s ²

For higher requirements please consult our technical dept.

A	B	C	D	R	Weight/m	Chain
mm	mm	mm	mm	mm	kg	Part Number
253	100	200	72	200-250-300-350-400-500	5,7	309C200 □□□ *
353	100	300	72	200-250-300-350-400-500	6,8	309C300 □□□ *
453	100	400	72	200-250-300-350-400-500	7,9	309C400 □□□ *

*Complete the code by inserting the value of the radius (R): Ex. 309C200 □□□□

4

R	H	N	M
mm	mm	mm	mm
200	506	350	830
250	606	400	985
300	706	455	1145
350	806	500	1300
400	906	555	1460
500	1106	650	1770

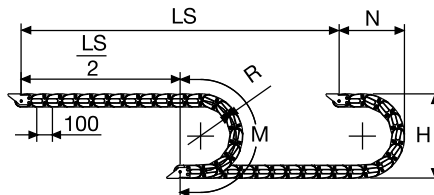

Length of chain (L)
Half travel distance ($\frac{LS}{2}$)
plus length of curve (M)

$$L = \frac{LS}{2} + M$$



Serie Protection

309C

Nylon Protection Cable Chain with opening covers

How to open the cover.

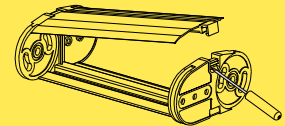
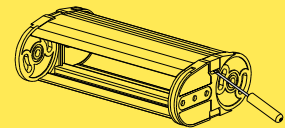

For further information please consult Brevetti Stendalto's Technical Office

Self-Supporting Capacity Diagram

The maximum length of the self-supporting capacity ($\frac{LS}{2}$) in relationship to the weight of the cables and hoses contained per linear metre.

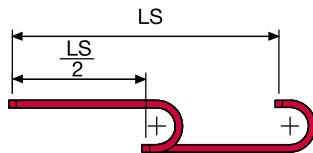
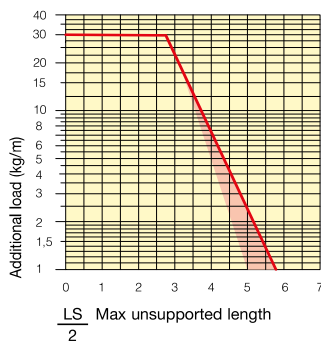

The red marking in the diagram area considers the difference of weight between various widths of chain.

For applications with $\frac{LS}{2}$ and weights not included in the area of the diagram showing self-supporting capacity, verify the possible use of support rollers (see page 30).

End Brackets

The end brackets set allows the two ends of the chain to be attached to the equipment.

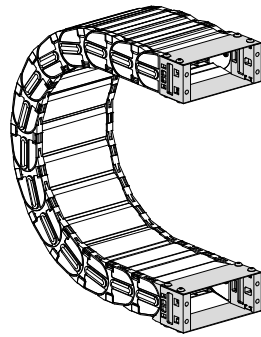
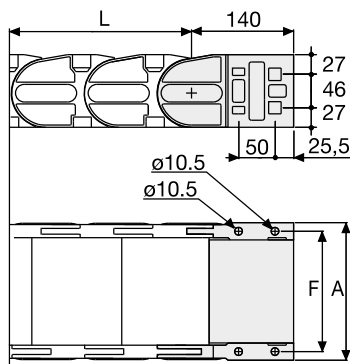

Fig. A
The chain can be fixed frontally, inner or outer radius. (Fig A)



Chain Type	F mm
309C200	229
309C300	329
309C400	429

Nylon Type Part Numbers

Complete Set Assembled	
Chain Type	End Brackets Set
309C200	AN309C200KM
309C300	AN309C300KM
309C400	AN309C400KM

Complete Set Unassembled	
Chain Type	End Brackets Set
309C200	AN309C200K
309C300	AN309C300K
309C400	AN309C400K

309CU Nylon Protection Cable Chain with opening aluminium covers

Inner height (D) 75,5 mm

Strong double share Sideband & Frame construction with large anti-friction triple-pin.

Covers are opening from inner and outer radius.

Vertical separators are available.

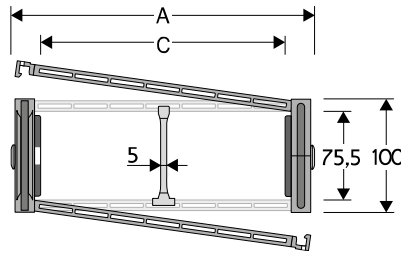

Separator

- Unassembled Part.no S309S/3178
- Assembled Part.no S309S/3178MCI for chain opening outer radius
- Assembled Part.no S309S/3178MCE for chain opening inner radius

Pin

Part.no PG309H

Technical characteristics when self-supported

Speed	8 m/s
Acceleration	40 m/s ²

For higher requirements please consult our technical dept.

A	B	C	D	R	Weight/m	Chain
mm	mm	mm	mm	mm	kg	Part Number
117	100	64	75,5	200-250-300-350-400-500-600	4,84	309CU064 □□□ *
137	100	84	75,5	200-250-300-350-400-500-600	5,12	309CU084 □□□ *
162	100	109	75,5	200-250-300-350-400-500-600	5,47	309CU109 □□□ *
169	100	116	75,5	200-250-300-350-400-500-600	5,58	309CU116 □□□ *
192	100	139	75,5	200-250-300-350-400-500-600	5,90	309CU139 □□□ *
232	100	179	75,5	200-250-300-350-400-500-600	6,47	309CU179 □□□ *
267	100	214	75,5	200-250-300-350-400-500-600	6,97	309CU214 □□□ *
293	100	240	75,5	200-250-300-350-400-500-600	7,35	309CU240 □□□ *
317	100	264	75,5	200-250-300-350-400-500-600	7,68	309CU264 □□□ *
343	100	290	75,5	200-250-300-350-400-500-600	8,04	309CU290 □□□ *
367	100	314	75,5	200-250-300-350-400-500-600	8,39	309CU314 □□□ *
393	100	340	75,5	200-250-300-350-400-500-600	8,74	309CU340 □□□ *
417	100	364	75,5	200-250-300-350-400-500-600	9,09	309CU364 □□□ *
472	100	419	75,5	200-250-300-350-400-500-600	9,98	309CU419 □□□ *
541	100	488	75,5	200-250-300-350-400-500-600	10,86	309CU488 □□□ *

*Complete the code by inserting the value of the radius (R): Ex. 309CU □□□ □

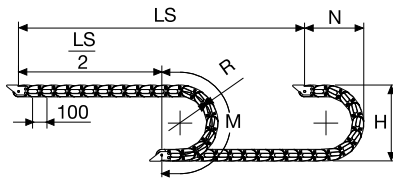

Length of chain (L)

Half travel distance ($\frac{LS}{2}$) plus length of curve (M)

$$L = \frac{LS}{2} + M$$

R	H	N	M
mm	mm	mm	mm
200	506	350	830
250	606	400	985
300	706	455	1145
350	806	500	1300
400	906	555	1460
500	1106	650	1770
600	1306	750	2085



Self-Supporting Capacity Diagram

The maximum length of the self-supporting capacity ($\frac{LS}{2}$) in relationship to the weight of the cables and hoses contained per linear metre.

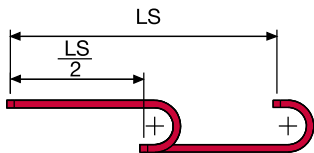
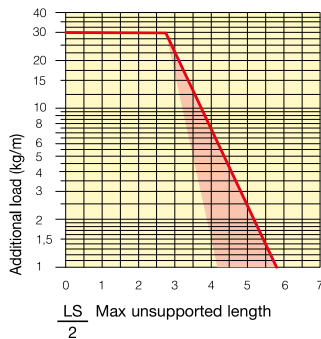

The red marking in the diagram area considers the difference of weight between various widths of chains assembled with nylon frames every second pitch.

For applications with $\frac{LS}{2}$ and weights not included in the area of the diagram showing self-supporting capacity, verify the possible use of support rollers (see page 30).

End Brackets

The end brackets set allows the two ends of the chain to be attached to the equipment. Set complete with tie-wrap clamps available on request.

Nylon Type

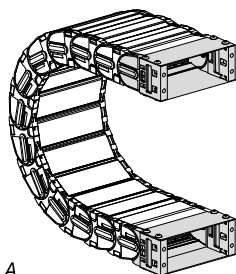

Fig. A
The chain can be fixed frontally, inner or outer radius. (Fig A)

Bright Zinc Plated Steel Type***

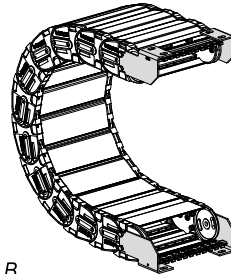
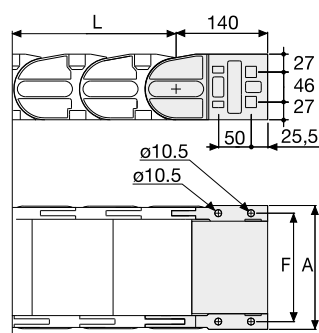

Fig. B
Chain fixed outside the radius. (Fig B)
See end brackets mounting variations page 31.



Chain Type	F mm
309CU064	92
309CU084	112
309CU109	137
309CU116	144
309CU139	167
309CU179	207
309CU214	242
309CU240	268
309CU264	292
309CU290	318
309CU314	342
309CU340	368
309CU364	392
309CU419	447
309CU488	516

Nylon Type Part Numbers

Complete Set Assembled Chain Type	End Brackets Set
309 AN309C□□□*KM	

Complete Set Unassembled Chain Type	End Brackets Set
309 AN309C□□□*K	

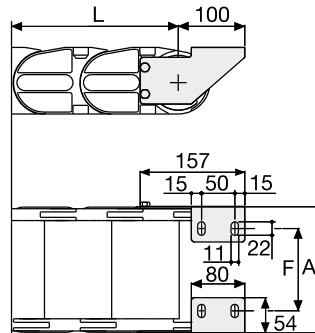

Chain Type	F mm
309CU064	50
309CU084	70
309CU109	95
309CU116	102
309CU139	125
309CU179	165
309CU214	200
309CU240	226
309CU264	250
309CU290	276
309CU314	300
309CU340	326
309CU364	350
309CU419	405
309CU488	474

Bright Zinc Plated Steel Type Part Numbers

Complete Set Assembled Chain Type	End Brackets Set
309 A309CU□□□*KM□**	

Complete Set Unassembled Chain Type	End Brackets Set
309 A309CU□□□*K□**	

Tiewrap Clamp
Assembl. SFCT309S □□□ *KM
Unassembl. SFCT309S □□□ *K
* Inner width (C)

Serie Protection

309CU

Nylon Protection Cable Chain with opening aluminium covers

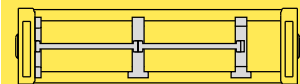

Separation System To choose the separators see page 216



For further information please consult Brevetti Stendato's Technical Office