

Opening  
and removable  
cover frames

Large selection  
of chain-frames:  
- aluminium draw plates  
cut to size;  
- aluminium drilled  
frames, according  
to customer drawings

Special tough construction  
with double spring washer,  
antifriction plates  
and rivet fixing

5

## 20LT Bright Zinc Plated Steel chain with aluminium frame

### Inner height (D) 32 mm

Bright Zinc Plated Steel chain<sup>1</sup>.  
Aluminium draw plates with nylon separator or Aluminium split cross piece created by design. A both can mounted every second links.

Alu-draw frames are standard mounted and every link. You can request the quote C with special quote.

<sup>(1)</sup> available in Stainless Steel.

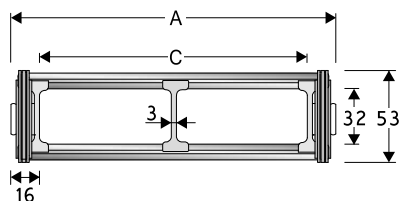

### Separator

- Unassembled	Part.no S20LTF
- Assembled	Part.no S20LTFMC

### Technical characteristics when self-supported

Speed	0,5 m/s
Acceleration	2 m/s <sup>2</sup>

For higher requirements please consult our technical dept.

For sliding applications, characteristics techniques may vary depending on the frequency, added weight and work environment.

### Aluminium frames with nylon separators

A	B	C	D	R	Weight/m	Chain
mm	mm	mm	mm	mm	kg	Part Number
111	53	79	32	075-115-150-205-250-305	4,41	20LT079 □□□ *
136	53	104	32	075-115-150-205-250-305	4,56	20LT104 □□□ *
186	53	154	32	075-115-150-205-250-305	4,86	20LT154 □□□ *
236	53	204	32	075-115-150-205-250-305	5,15	20LT204 □□□ *
286	53	254	32	075-115-150-205-250-305	5,45	20LT254 □□□ *
336	53	304	32	075-115-150-205-250-305	5,75	20LT304 □□□ *
C+32	53	....	32	075-115-150-205-250-305		20LT □□□ □□□ **

\*Complete the code by inserting the value of the radius (R): Ex. 20LT154 □□□ □□

\*\*Complete the code by inserting the value of the quote C and the radius (R): Ex 20LT □□□ □□□ □□□ □□

Chain equipped with aluminium draw plates every pitch: complete the code by inserting the letter D: Es. 20LT154250 □□

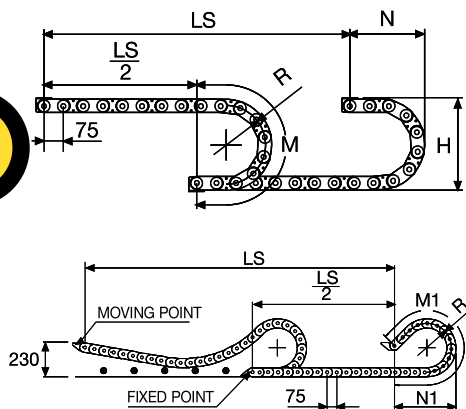

Length of chain (L)

Half travel distance ( $\frac{LS}{2}$ )

plus length of curve (M) or (M1)

$$L = \frac{LS}{2} + M \text{ or } M1$$

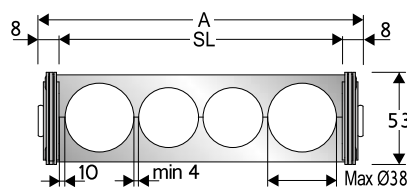

### Machined Cross Frame

Machined cross frames 20LA available on request for bending radius listed below. Custom solutions for machined cross frames realization, based on customer's and/or specific requirements. Please contact Brevetti Stendalto's Technical Department for further information.

R	H*	N	M	N1	M1
mm	mm	mm	mm	mm	mm
075	216	180	390	-	-
115	296	220	515	500	1080
150	366	255	625	675	1485
205	476	310	795	885	2005
250	566	360	940	1030	2385
305	676	410	1110	1190	2825

\* The height H should be increased by 10 mm/m approx. because of preload. In case of limitation to available space, refer to the Technical Dptm.



### Self-Supporting Capacity Diagram

The maximum length of the self-supporting capacity ( $\frac{LS}{2}$ ) in relationship to the weight of the cables and hoses contained per linear metre.

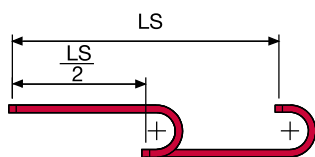
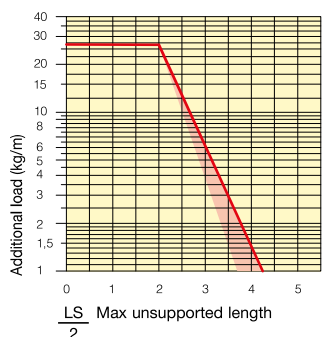

The red marking in the diagram area considers the difference of weight between various widths of chain.

For applications with  $\frac{LS}{2}$  and weights not included in the area of the diagram showing self-supporting capacity, verify the possible use of support rollers (see page 30).

### Bright Zinc Plated Steel End Brackets

The end brackets set containing four steel plates screwed to the links allows the two ends of the chain to be attached to the equipment.

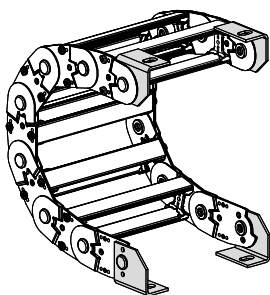
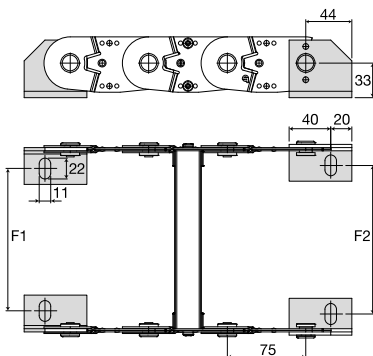

Fig. A  
Chain fixed inner/outer the radius (Fig A)



Chain type	F1 mm	F2 mm
20LT079	61	67
20LT104	86	92
20LT154	136	142
20LT204	186	192
20LT254	236	242
20LT304	286	292

Special widths  
F1=A-50 F2=A-44

### Bright Zinc Plated Steel Type Part Numbers

Complete Set Assembled Chain type	End Brackets Set
20LT...	A20LKM□**

Complete Set Unassembled Chain type	End Brackets Set
20LT ...	A20LK

\*\* 1=Pos.1; 2=Pos.2; 3=Pos.3

### Serie Steel

## 20LT

Bright Zinc Plated Steel chain with aluminium frame

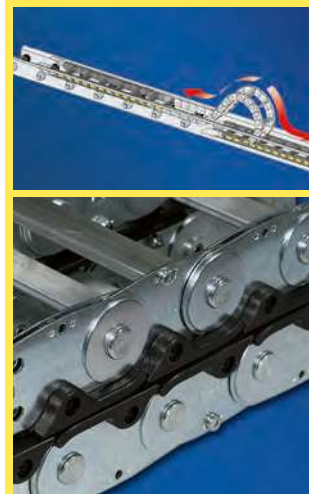

Suitable to long travel distance.  
See page 240

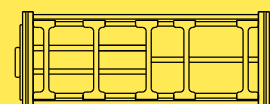

Supplementary movable separators.



For further information please consult Brevetti Stendalto's Technical Office

## 20LC

### Bright Zinc Plated Steel chain with aluminium covers

#### Inner height (D) 31 mm

Bright Zinc Plated Steel chain<sup>1</sup>.  
The cover is of Aluminium.  
You can request the quote C with special quote.  
<sup>(1)</sup> available in Stainless Steel.

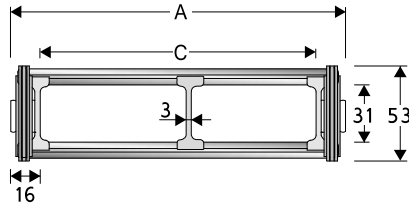

#### Separator

- Unassembled	Part.no S20LTF
- Assembled	Part.no S20LTFMC

#### Technical characteristics when self-supported

Speed	0,5 m/s
Acceleration	2 m/s <sup>2</sup>

For higher requirements please consult our technical dept.

For sliding applications, characteristics techniques may vary depending on the frequency, added weight and work environment.

#### Aluminium draw Plates with Nylon Separators

A	B	C	D	R	Weight/m	Chain
mm	mm	mm	mm	mm	kg	Part Number
111	53	79	31	115-150-205-250-305	5,73	20LC079 □□□ *
136	53	104	31	115-150-205-250-305	6,21	20LC104 □□□ *
186	53	154	31	115-150-205-250-305	7,18	20LC154 □□□ *
236	53	204	31	115-150-205-250-305	8,15	20LC204 □□□ *
286	53	254	31	115-150-205-250-305	9,12	20LC254 □□□ *
336	53	304	31	115-150-205-250-305	10,09	20LC304 □□□ *
C+32	53	....	31	115-150-205-250-305		20LC □□□□□ **

\*Complete the code by inserting the value of the radius (R): Ex. 20LC154 □ □ □ □

\*\*Complete the code by inserting the value of the quote C and the radius (R): Ex. 20LC □ □ □ □ □ □ □ □

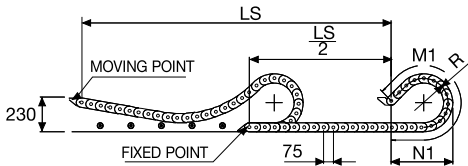
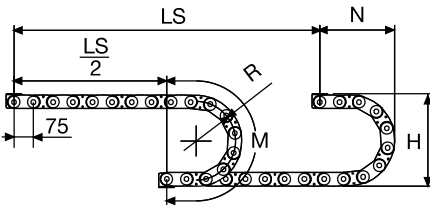

R	H*	N	M	N1	M1
mm	mm	mm	mm	mm	mm
115	296	220	515	500	1080
150	366	255	625	675	1485
205	476	310	795	885	2005
250	566	360	940	1030	2385
305	676	410	1110	1190	2825

\* The height H should be increased by 10 mm/m approx. because of preload. In case of limitation to available space, refer to the Technical Dptm.

Length of chain (L)

Half travel distance ( $\frac{LS}{2}$ )

plus length of curve (M) or (M1)

$$L = \frac{LS}{2} + M \text{ or } M1$$



### Self-Supporting Capacity Diagram

The maximum length of the self-supporting capacity ( $\frac{LS}{2}$ ) in relationship to the weight of the cables and hoses contained per linear metre.

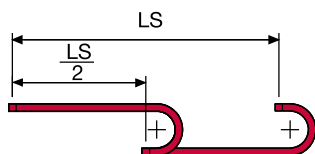
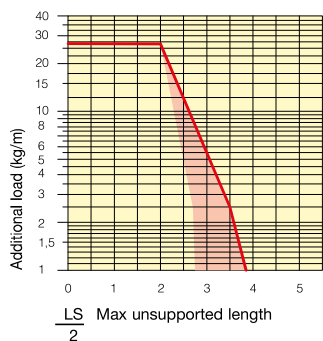

The red marking in the diagram area considers the difference of weight between various widths of chain.

For applications with  $\frac{LS}{2}$  and weights not included in the area of the diagram showing self-supporting capacity, verify the possible use of support rollers (see page 30).

### Bright Zinc Plated Steel End Brackets

The end brackets set containing four steel plates screwed to the links allows the two ends of the chain to be attached to the equipment.

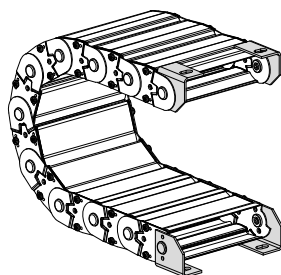
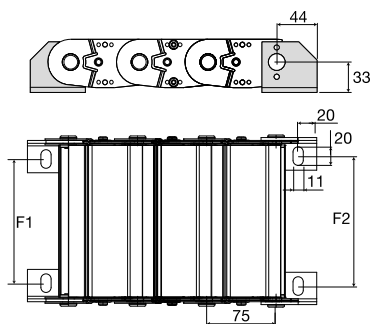

Fig. A  
Chain fixed outer radius (Fig A)



Chain type	F1 mm	F2 mm
20LC079	61	67
20LC104	86	92
20LC154	136	142
20LC204	186	192
20LC254	236	242
20LC304	286	292
Special widths		
F1=A-50	F2=A-44	

### Bright Zinc Plated Steel Type Part Number

Complete Set Assembled	
Chain type	End Brackets Set
20LC...	A20LCKM□**

Complete Set Unassembled	
Chain type	End Brackets Set
20LC...	A20CLK

\*\* 1=Pos.1; 2=Pos.2; 3=Pos.3

### Serie Steel

## 20LC

Zinc plated steel chain with aluminium covers

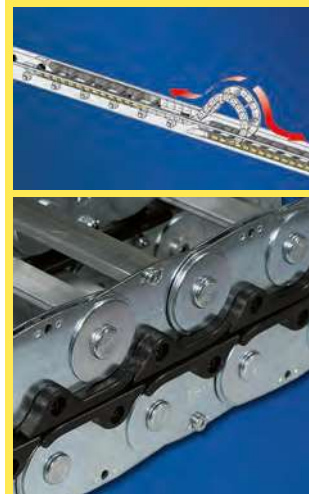

Suitable to long travel distance. See page 240



For further information please consult Brevetti Stendalto's Technical Office

## 30LT

### Bright Zinc Plated Steel Cable Chains

#### Inner height (D) 52 mm

Zinc coated ultra-high-strength steel cable chain.

Available with aluminium frames (LT) or with aluminium holed cross-pieces (LA) mounted each second link.

Full-links frames assembling available on demand.

Inner width C can be required at the needed size.

Stainless steel 316L available on demand.

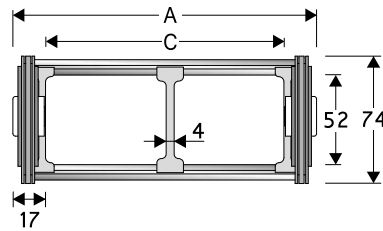

#### Separator

- Unassembled Part.no. S308CO
- Assembled Part.no. S308COMC

#### Technical characteristics

Speed	0,5 m/s
Acceleration	2 m/s <sup>2</sup>

For higher requirements please consult our technical dept.

For sliding applications, characteristics techniques may vary depending on the frequency, added weight and work environment.

#### Aluminium frames with nylon separators

A	B	C	D	R	Weight/m	Chain
mm	mm	mm	mm	mm	kg	Part Number
140	74	106	52	150-220-250-305-400-535	6,20	30LT106□□□*
190	74	156	52	150-220-250-305-400-535	6,44	30LT156□□□*
240	74	206	52	150-220-250-305-400-535	6,68	30LT206□□□*
290	74	256	52	150-220-250-305-400-535	6,92	30LT256□□□*
340	74	306	52	150-220-250-305-400-535	7,16	30LT306□□□*
390	74	356	52	150-220-250-305-400-535	7,40	30LT356□□□*
440	74	406	52	150-220-250-305-400-535	7,65	30LT406□□□*
490	74	456	52	150-220-250-305-400-535	7,89	30LT456□□□*
540	74	506	52	150-220-250-305-400-535	8,13	30LT506□□□*
C+34	74	....	52	150-220-250-305-400-535		30LT□□□□□**

\*Complete the code by inserting the value of the radius (R): Ex. 30LT156□□□□

\*\*Complete the code by inserting the value of the quote C and the radius (R): Ex. 30LT□□□□□□□□

Chain equipped with aluminium draw plates every pitch: complete the code by inserting the letter D. Ex. 30LT156250□

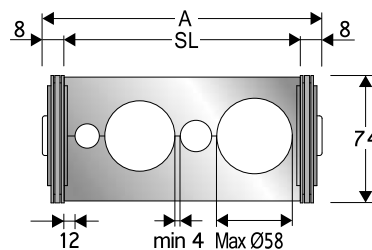
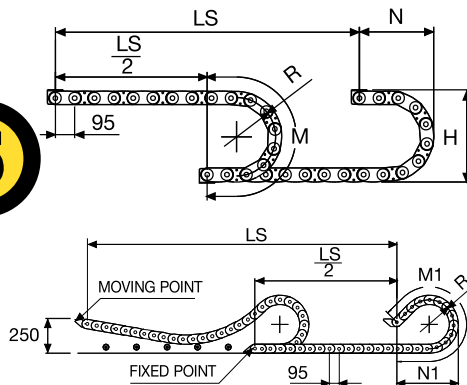

#### Machined Cross Frame

Machined cross frames 30LA available on request for bending radius listed below. Custom solutions for machined cross frames realization, based on customer's and/or specific requirements. Please contact Brevetti Stendatto's Technical Department for further information.

R	H*	N	M	N1	M1
mm	mm	mm	mm	mm	mm
150	388	290	670	830	1770
220	528	360	890	1145	2515
250	588	385	980	1255	2800
305	698	440	1150	1450	3285
400	888	540	1450	1740	4065
535	1158	675	1880	2110	5105

\*The height H should be increased by 10 mm/m approx. because of preload. In case of limitation to the available space, refer to the Technical Deptm.

Length of chain (L)

Half travel distance ( $\frac{LS}{2}$ )

plus length of curve (M) or (M1)

$$L = \frac{LS}{2} + M \text{ or } M1$$



### Self-Supporting Capacity Diagram

The maximum length of the self-supporting capacity ( $\frac{LS}{2}$ ) in relationship to the weight of the cables and hoses contained per linear metre.

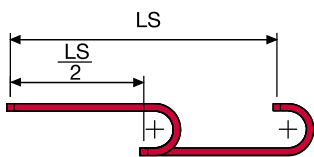
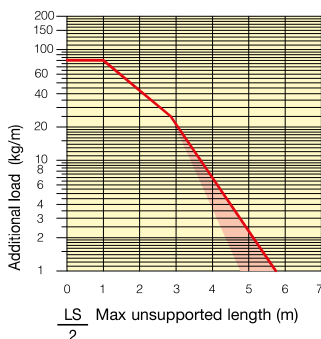

The red marking in the diagram area considers the difference of weight between various widths of chain assembled with frames every second pitch.

For applications with  $\frac{LS}{2}$  and weights not included in the area of the diagram showing self-supporting capacity, verify the possible use of support rollers (see page 30).

### Bright Zinc Plated Steel End Brackets

The end brackets set, containing four steel plates screwed to the links allows the two ends of the chain to be attached to the equipment.

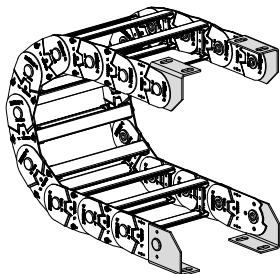
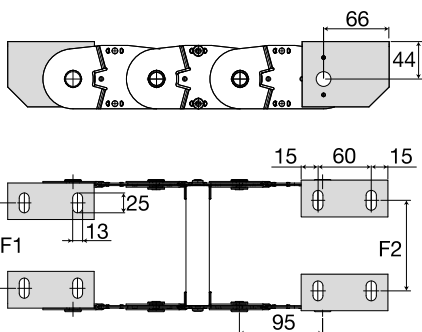

Fig. A  
Chain fixed outer radius. (Fig A)



Chain Type	F1 mm	F2 mm
30LT106	77	83
30LT156	127	133
30LT206	177	183
30LT256	227	233
30LT306	277	283
30LT356	327	333
30LT406	377	383
30LT456	427	433
30LT506	477	483
Special widths		
F1=A-63	F2=A-57	

### Bright Zinc Plated Steel Type Part Numbers

Complete Set Assembled	End Brackets
Chain	End Brackets
Type	Set
30LT...	A30LKM□**

Complete Set Unassembled	End Brackets
Chain	End Brackets
Type	Set
30LT...	A30LK

\*\* 1=Pos.1; 2=Pos.2; 3=Pos.3

### Serie Steel

## 30LT

### Bright Zinc Plated Steel Cable Chains

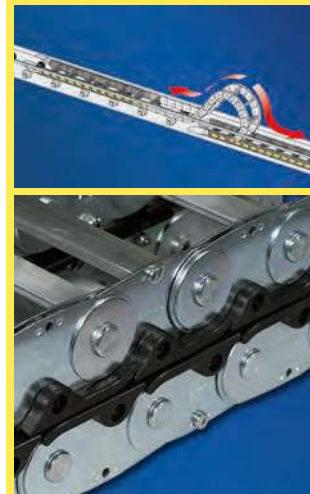

Suitable to long travel distance.  
See page 241

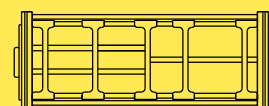

Supplementary movable separators.



For further information please consult Brevetti Stendalto's Technical Office.

## 30LC

### Bright zinc plated steel cable chain with aluminium covers

#### Inner height (D) 52 mm

Bright Zinc Plated Steel Cable Chain with aluminium cover and the quote C can be in special size. Available it can be done in Stainless steel.

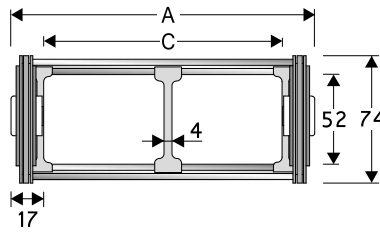

#### Separator

- Unassembled	Part.no	S308CO
- Assembled	Part.no	S308COMC

#### Technical characteristics

Speed	0,5 m/s
Acceleration	2 m/s <sup>2</sup>

For higher requirements please consult our technical dept.

For sliding applications, characteristics techniques may vary depending on the frequency, added weight and work environment.

#### Aluminium frames with nylon separators

A	B	C	D	R	Weight/m	Chain
mm	mm	mm	mm	mm	kg	Part Number
140	74	106	52	150-220-250-305-400-535	7,96	30LC106□□□*
190	74	156	52	150-220-250-305-400-535	8,87	30LC156□□□*
240	74	206	52	150-220-250-305-400-535	9,79	30LC206□□□*
290	74	256	52	150-220-250-305-400-535	10,70	30LC256□□□*
340	74	306	52	150-220-250-305-400-535	11,61	30LC306□□□*
390	74	356	52	150-220-250-305-400-535	12,53	30LC356□□□*
440	74	406	52	150-220-250-305-400-535	13,44	30LC406□□□*
490	74	456	52	150-220-250-305-400-535	14,36	30LC456□□□*
540	74	506	52	150-220-250-305-400-535	15,27	30LC506□□□*
C+34	74	....	52	150-220-250-305-400-535		30LC□□□□□**

\*Complete the code by inserting the value of the radius (R): Ex. 30LC156[2][5][0]

\*\*Complete the code by inserting the value of the quote C and the radius (R): Ex. 30LC[7][2][3][2][5][0]

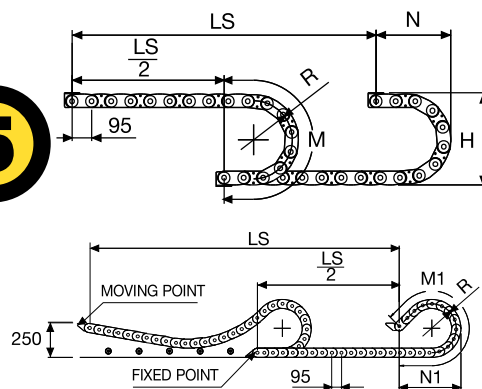

R	H*	N	M	N1	M1
mm	mm	mm	mm	mm	mm
150	388	290	670	830	1770
220	528	360	890	1145	2515
250	588	385	980	1255	2800
305	698	440	1150	1450	3285
400	888	540	1450	1740	4065
535	1158	675	1880	2110	5105

\*The height H should be increased by 10 mm/m approx. because of preload. In case of limitation to the available space, refer to the Technical Dptm.





### Self-Supporting Capacity Diagram

The maximum length of the self-supporting capacity ( $\frac{LS}{2}$ ) in relationship to the weight of the cables and hoses contained per linear metre.

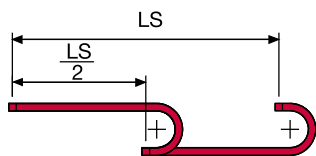
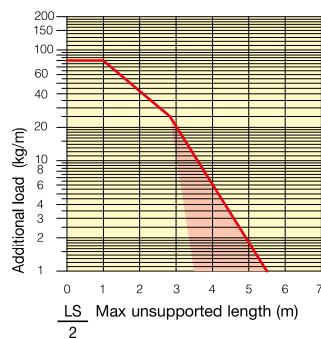

The red marking in the diagram area considers the difference of weight between various widths of chain.

For applications with  $\frac{LS}{2}$  and weights not included in the area of the diagram showing self-supporting capacity, verify the possible use of support rollers (see page 30).

### Bright Zinc Plated Steel End Brackets

The end brackets set, containing four steel plates screwed to the links allows the two ends of the chain to be attached to the equipment.

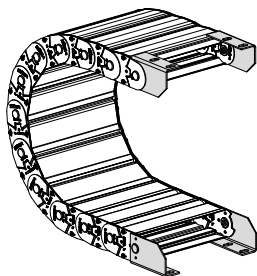
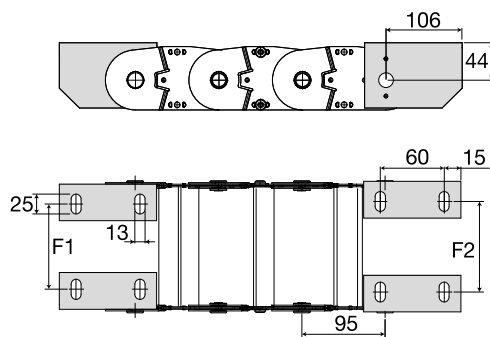

Fig. A  
Chain fixed outer radius. (Fig A)



Chain Type	F1 mm	F2 mm
30LC106	77	83
30LC156	127	133
30LC206	177	183
30LC256	227	233
30LC306	277	283
30LC356	327	333
30LC406	377	383
30LC456	427	433
30LC506	477	483
Special widths		
F1=A-63	F2=A-57	

### Bright Zinc Plated Steel Type Part Numbers

Complete Set Assembled	Chain	End Brackets
Type	Set	
30LC...	A30LCKM□**	

Complete Set Unassembled	Chain	End Brackets
Type	Set	
30LC...	A30LCK	

\*\* 1=Pos.1; 2=Pos.2; 3=Pos.3

### Serie Steel

## 30LC

Bright zinc plated steel cable chain with aluminium covers



Suitable to long travel distance. See page 241



For further information please consult Brevetti Stendalto's Technical Office.

## 35LT

### Bright zinc plated steel cable chain with Alu-frames

#### Inner height (D) 65 mm

Bright Zinc Plated Steel Cable Chain.<sup>1</sup>  
Aluminium Holed cross pieces designed or Alu-frame are mounted each second link. Quote C can be in special size.

<sup>(1)</sup> available in Stainless Steel.

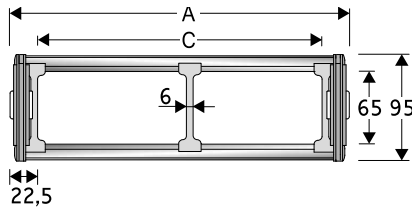

#### Separator

- Unassembled	Part.no	ST3500F
- Assembled	Part.no	ST3500FMC

#### Technical characteristics when self-supported

Speed	0,5 m/s
Acceleration	2 m/s <sup>2</sup>

For higher requirements please consult our technical dept.

For sliding applications, characteristics techniques may vary depending on the frequency, added weight and work environment.

#### Aluminium frames with nylon separators

A	B	C	D	R	Weight/m	Chain
mm	mm	mm	mm	mm	kg	Part Number
149	95	104	65	200-250-300-350-400-450-500-600	10,30	35LT104□□□*
199	95	154	65	200-250-300-350-400-450-500-600	10,67	35LT154□□□*
249	95	204	65	200-250-300-350-400-450-500-600	11,04	35LT204□□□*
299	95	254	65	200-250-300-350-400-450-500-600	11,41	35LT254□□□*
349	95	304	65	200-250-300-350-400-450-500-600	11,78	35LT304□□□*
399	95	354	65	200-250-300-350-400-450-500-600	12,15	35LT354□□□*
449	95	404	65	200-250-300-350-400-450-500-600	12,52	35LT404□□□*
499	95	454	65	200-250-300-350-400-450-500-600	12,89	35LT454□□□*
549	95	504	65	200-250-300-350-400-450-500-600	13,26	35LT504□□□*
C+45	95	....	65	200-250-300-350-400-450-500-600		35LT□□□□□**

\*Complete the code by inserting the value of the radius (R): Ex. 35LT154□□□□

\*\*Complete the code by inserting the value of the quote C and the radius (R): Ex. 35LT□□□□□□□□

Chain equipped with aluminium draw plates every pitch: complete the code by inserting the letter D. Ex. 35LT154250□

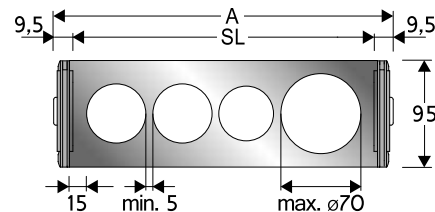
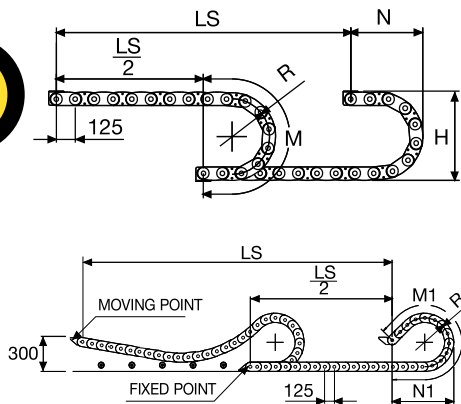

#### Machined Cross Frame

Machined cross frames 35LA available on request for bending radius listed below. Custom solutions for machined cross frames realization, based on customer's and/or specific requirements. Please contact Brevetti Stendalto's Technical Department for further information.

R	H*	N	M	N1	M1
mm	mm	mm	mm	mm	mm
200	512	375	880	1100	2360
250	612	425	1040	1310	2870
300	712	480	1200	1495	3335
350	812	525	1350	1670	3775
400	912	575	1510	1825	4190
450	1012	625	1670	1975	4595
500	1112	675	1825	2120	4985
600	1312	775	2140	2390	5750

\*The height H should be increased by 10 mm/m approx. because of preload. In case of limitation to the available space, refer to the Technical Dptm.

Length of chain (L)

Half travel distance ( $\frac{LS}{2}$ )

plus length of curve (M) or (M1)

$$L = \frac{LS}{2} + M \text{ or } M1$$



### Self-Supporting Capacity Diagram

The maximum length of the self-supporting capacity ( $\frac{LS}{2}$ ) in relationship to the weight of the cables and hoses contained per linear metre.

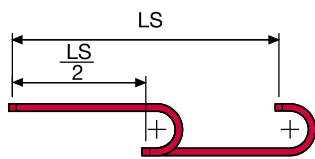
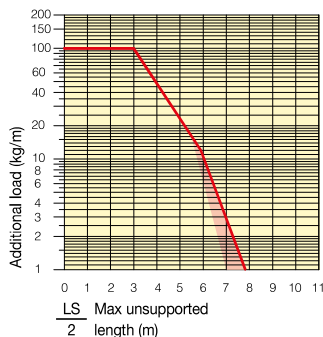

The red marking in the diagram area considers the difference of weight between various widths of chain.

For applications with  $\frac{LS}{2}$  and weights not included in the area of the diagram showing self-supporting capacity, verify the possible use of support rollers (see page 30).

### Bright Zinc Plated Steel End Brackets

The end brackets set, containing four steel plates screwed to the links allows the two ends of the chain to be attached to the equipment.

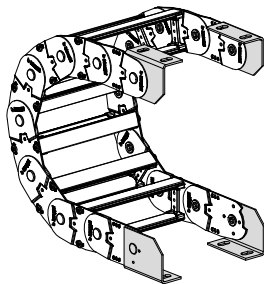
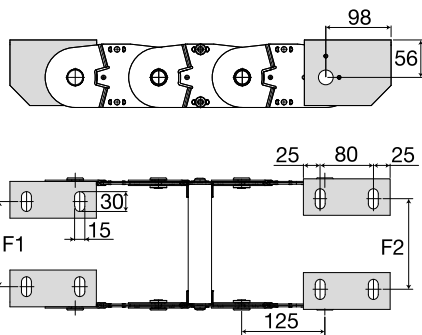

Fig. A  
Chain fixed outer radius (Fig A)



Chain type	F1 mm	F2 mm
35LT104	78	86
35LT154	128	136
35LT204	178	186
35LT254	228	236
35LT304	278	286
35LT354	328	336
35LT404	378	386
35LT454	428	436
35LT504	478	486
Special widths		
F1=A-71,5	F2=A-63,5	

### Bright Zinc Plated Steel Type Part Numbers

Complete Set Assembled	Chain	End Brackets
type		Set
35LT...		A35LKM□**

Complete Set Unassembled	Chain	End Brackets
type		Set
35LT...		A35LK

\*\* 1=Pos.1; 2=Pos.2; 3=Pos.3

### Serie Steel

## 35LT

Bright zinc plated steel cable chain with Alu-frames

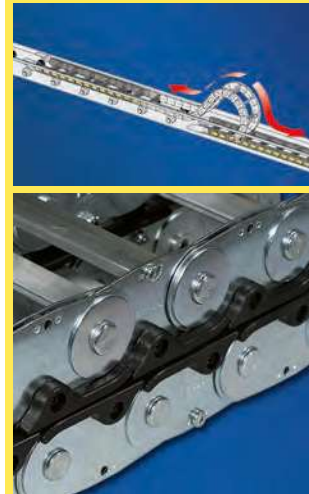

Suitable to long travel distance  
See page 242

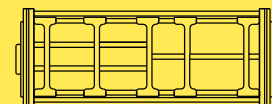

Supplementary movable separators.



For further information please consult Brevetti Stendalto's Technical Office

## 35LC

### Stainless steel cable chain with the aluminium covers

#### Inner height (D) 65 mm

Bright Zinc Plated Steel Cable Chain with aluminium cover and the quote C can be in special size. Available it can be done in Stainless steel.

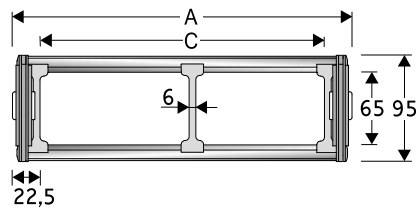

#### Separator

- Unassembled	Part.no	ST3500F
- Assembled	Part.no	ST3500FMC

#### Technical characteristics when self-supported

Speed	0,5 m/s
Acceleration	2 m/s <sup>2</sup>

For higher requirements please consult our technical dept.

For sliding applications, characteristics techniques may vary depending on the frequency, added weight and work environment.

#### Aluminium frames with nylon separators

A	B	C	D	R	Weight/m	Chain
mm	mm	mm	mm	mm	kg	Part Number
149	95	104	65	200-250-300-350-400-450-500-600	12,20	35LC104□□□*
199	95	154	65	200-250-300-350-400-450-500-600	13,23	35LC154□□□*
249	95	204	65	200-250-300-350-400-450-500-600	14,26	35LC204□□□*
299	95	254	65	200-250-300-350-400-450-500-600	15,29	35LC254□□□*
349	95	304	65	200-250-300-350-400-450-500-600	16,32	35LC304□□□*
399	95	354	65	200-250-300-350-400-450-500-600	17,35	35LC354□□□*
449	95	404	65	200-250-300-350-400-450-500-600	18,37	35LC404□□□*
499	95	454	65	200-250-300-350-400-450-500-600	19,40	35LC454□□□*
549	95	504	65	200-250-300-350-400-450-500-600	20,43	35LC504□□□*
C+45	95	....	65	200-250-300-350-400-450-500-600		35LC□□□□□**

\*Complete the code by inserting the value of the radius (R): Ex. 35LC154[2][5][0]

\*\*Complete the code by inserting the value of the quote C and the radius (R): Ex. 35LC[7][2][3][2][5][0]

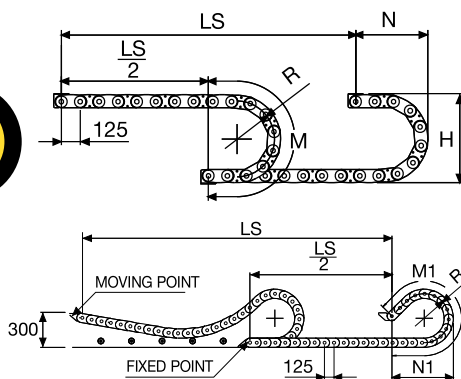

Length of chain (L)

Half travel distance ( $\frac{LS}{2}$ )

plus length of curve (M) or (M1)

$$L = \frac{LS}{2} + M \text{ or } M1$$

R	H*	N	M	N1	M1
mm	mm	mm	mm	mm	mm
200	512	375	880	1100	2360
250	612	425	1040	1310	2870
300	712	480	1200	1495	3335
350	812	525	1350	1670	3775
400	912	575	1510	1825	4190
450	1012	625	1670	1975	4595
500	1112	675	1825	2120	4985
600	1312	775	2140	2390	5750

\*The height H should be increased by 10 mm/m approx. because of preload. In case of limitation to the available space, refer to the Technical Deptm.

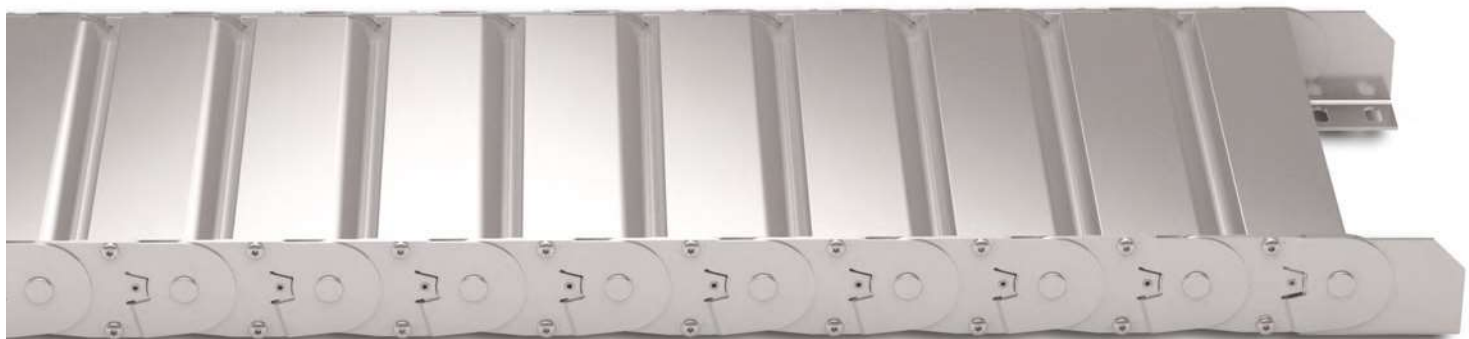

### Self-Supporting Capacity Diagram

The maximum length of the self-supporting capacity ( $\frac{LS}{2}$ ) in relationship to the weight of the cables and hoses contained per linear metre.

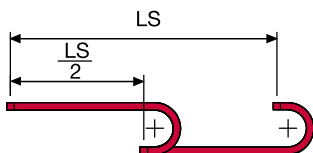
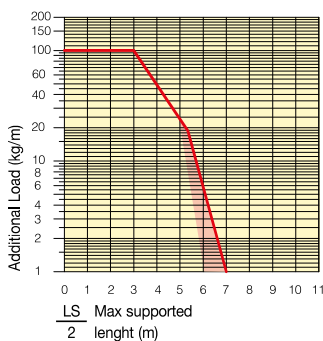

The red marking in the diagram area considers the difference of weight between various widths of chain.

For applications with  $\frac{LS}{2}$  and weights not included in the area of the diagram showing self-supporting capacity, verify the possible use of support rollers (see page 30).

### Bright Zinc Plated Steel End Brackets

The end brackets set, containing four steel plates screwed to the links allows the two ends of the chain to be attached to the equipment.

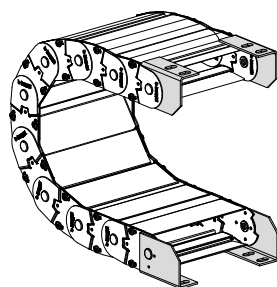
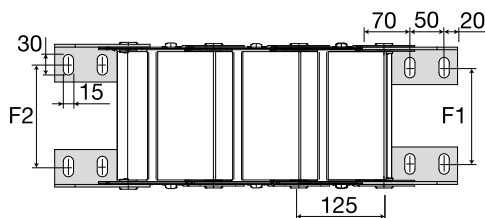
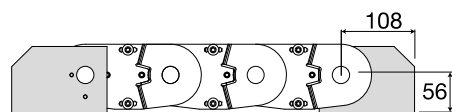

Fig. A  
Chain fixed outer radius (Fig A)



Chain Type	F1 mm	F2 mm
35LC104	78	86
35LC154	128	136
35LC204	178	186
35LC254	228	236
35LC304	278	286
35LC354	328	336
35LC404	378	386
35LC454	428	436
35LC504	478	486
Special widths		
F1=A-71,5	F2=A-63,5	

### Bright Zinc Plated Steel Type Part Numbers

Complete Set Assemble	
Chain type	End Brackets Set
35LC...	A35LCKM□**

Complete Set Unassemble	
Chain type	End Brackets Set
35LC...	A35LCK

\*\* 1=Pos.1; 2=Pos.2; 3=Pos.3

### Serie Steel

## 35LC

Stainless steel cable chain with the aluminium covers

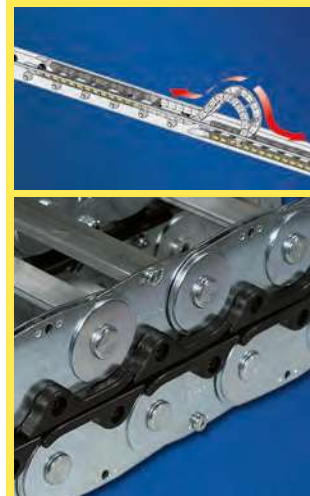

Suitable to long travel distance  
See page 242



For further information please consult Brevetti Stendato's Technical Office

## 40LT

### Bright zinc plated steel cable chain with Alu-frames

#### Inner height (D) 112,5 mm

Bright Zinc Plated Steel Cable Chain.<sup>1</sup>  
Aluminium Holed cross pieces designed or Alu-frame are mounted each every link. Quote C can be in special quote.

<sup>(1)</sup> available in Stainless Steel.

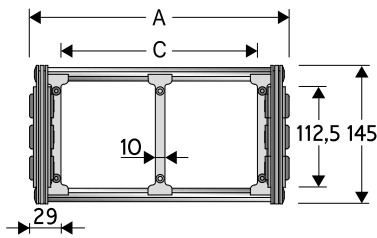

#### Separator

- Unassembled	Part.no S310TCF9
- Assembled	Part.no S310TCF9MC

#### Technical characteristics when self-supported

Speed	0,5 m/s
Acceleration	2 m/s <sup>2</sup>

For higher requirements please consult our technical dept.

For sliding applications, characteristics techniques may vary depending on the frequency, added weight and work environment.

#### Aluminium frames with nylon separators

A	B	C	D	R	Weight/m	Chain
mm	mm	mm	mm	mm	kg	Part Number
208	145	150	112,5	250-300-350-400-450-500-550-600-700-750-850	19,30	40LT150 □□□ *
258	145	200	112,5	250-300-350-400-450-500-550-600-700-750-850	19,76	40LT200 □□□ *
308	145	250	112,5	250-300-350-400-450-500-550-600-700-750-850	20,22	40LT250 □□□ *
358	145	300	112,5	250-300-350-400-450-500-550-600-700-750-850	20,68	40LT300 □□□ *
458	145	400	112,5	250-300-350-400-450-500-550-600-700-750-850	21,61	40LT400 □□□ *
558	145	500	112,5	250-300-350-400-450-500-550-600-700-750-850	22,53	40LT500 □□□ *
C+58	145	....	112,5	250-300-350-400-450-500-550-600-700-750-850		40LT □□□□□ **

\*Complete the code by inserting the value of the radius (R): Ex. 40LT150 □ □ □ □

\*\*Complete the code by inserting the value of the quote C and the radius (R): Ex. 40LT □ □ □ □ □ □ □ □

5

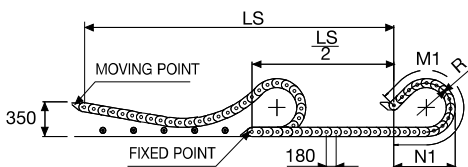
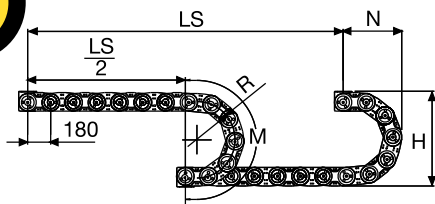

Length of chain (L)

Half travel distance ( $\frac{LS}{2}$ )

plus length of curve (M) or (M1)

$$L = \frac{LS}{2} + M \text{ or } M1$$

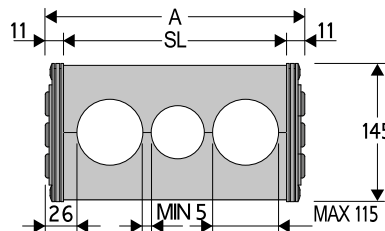

#### Machined Cross Frame

Machined cross frames 40LA available on request for bending radius listed below.

Custom solutions for machined cross frames realization, based on customer's and/or specific requirements.

Please contact Brevetti Stendalto's Technical Department for further information.

R	H*	N	M	N1	M1
mm	mm	mm	mm	mm	mm
250	664	510	1150	1545	3285
300	764	555	1305	1755	3790
350	864	605	1460	1950	4265
400	964	655	1620	2125	4715
450	1064	710	1780	2295	5150
500	1164	755	1930	2455	5570
550	1264	805	2090	2605	5975
600	1364	855	2245	2755	6375
700	1564	955	2560	3035	7155
750	1664	1010	2720	3170	7535
850	1864	1105	3030	3430	8280
1000	2164	1255	3500	-	-

\* The height H should be increased by 10 mm/m approx. because of preload. In case of limitation to available space, refer to the Technical Dptm.



### Self-Supporting Capacity Diagram

The maximum length of the self-supporting capacity ( $\frac{LS}{2}$ ) in relationship to the weight of the cables and hoses contained per linear metre.

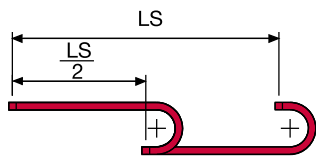
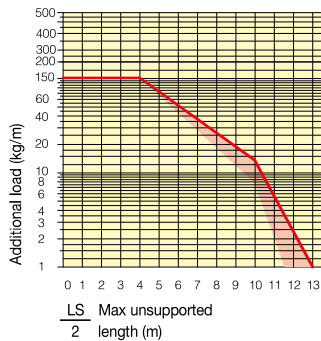

The red marking in the diagram area considers the difference of weight between various widths of chain.

For applications with  $\frac{LS}{2}$  and weights not included in the area of the diagram showing self-supporting capacity, verify the possible use of support rollers (see page 30).

### Bright Zinc Plated Steel End Brackets

The end brackets set, containing four steel plates screwed to the links allows the two ends of the chain to be attached to the equipment.

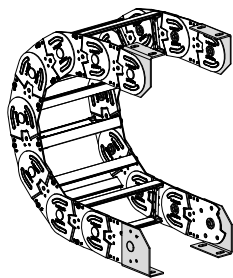
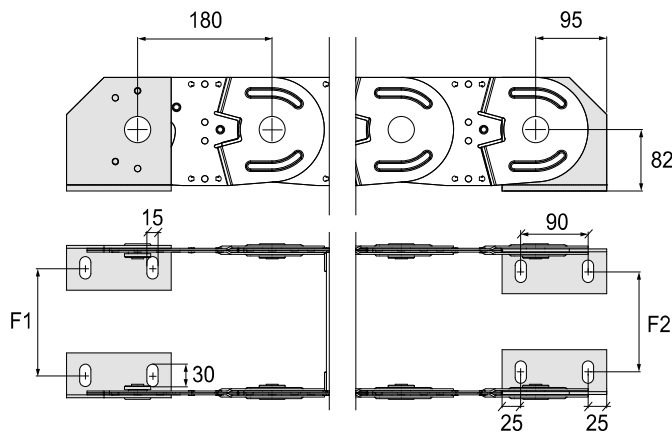

Fig. A  
Chain fixed outer radius (Fig A)  
See mounting variations page 31



Chain type	F1 mm
40LT150	135
40LT200	185
40LT250	235
40LT300	285
40LT400	385
40LT500	485
Special Widths	F=A-73

Chain type	F2 mm
40LT150	144
40LT200	194
40LT250	244
40LT300	294
40LT400	394
40LT500	494
Special Widths	F=A-64

### Bright Zinc Plated Steel Type Part Numbers

Complete Set Assembled Chain type	End Brackets Set
40...	A40LKM □ **

Complete Set Unassembled Chain type	End Brackets Set
40...	A40LK

\*\* 1=Pos.1; 2=Pos.2; 3=Pos.3  
See mounting variations page 31

### Serie Steel

## 40LT

Bright zinc plated steel cable chain with Alu-frame

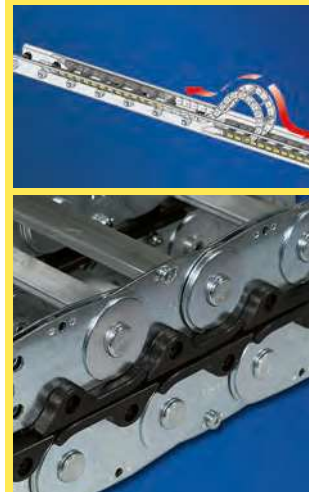

Suitable to long travel distance  
See page 243

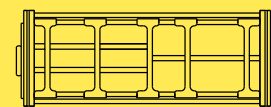

Supplementary movable separators



For further information please consult Brevetti Stendalto's Technical Office

## 40LC Zinc plated steel chain with aluminium cover

### Inner height (D) 104,5 mm

Bright Zinc Plated Steel Cable Chain with aluminium cover and the quote C can be in special size. Available it can be done in Stainless steel.

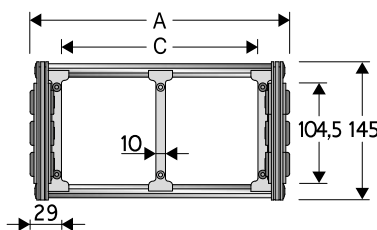

### Separator

- Unassembled	Part.no S310TCF9
- Assembled	Part.no S310TCF9MC

### Technical characteristics when self-supported

Speed	0,5 m/s
Acceleration	2 m/s <sup>2</sup>

For higher requirements please consult our technical dept.

### Aluminium Draw Plates with nylon separators

A	B	C	D	R	Weight/m	Chain
mm	mm	mm	mm	mm	kg	Part Number
208	145	150	104,5	250-300-350-400-450-500-550-600-700-750-850	22,47	<b>40LC150</b> □□□□ *
258	145	200	104,5	250-300-350-400-450-500-550-600-700-750-850	23,84	<b>40LC200</b> □□□□ *
308	145	250	104,5	250-300-350-400-450-500-550-600-700-750-850	25,20	<b>40LC250</b> □□□□ *
358	145	300	104,5	250-300-350-400-450-500-550-600-700-750-850	26,56	<b>40LC300</b> □□□□ *
458	145	400	104,5	250-300-350-400-450-500-550-600-700-750-850	29,28	<b>40LC400</b> □□□□ *
558	145	500	104,5	250-300-350-400-450-500-550-600-700-750-850	31,01	<b>40LC500</b> □□□□ *
C+58	145	....	104,5	250-300-350-400-450-500-550-600-700-750-850		<b>40LC</b> □□□□□□ **

\*Complete the code by inserting the value of the radius (R): Ex. 40LC150 □ □ □ □

\*\*Complete the code by inserting the value of the quote C and the radius (R): Ex. 40LC □ □ □ □ □ □

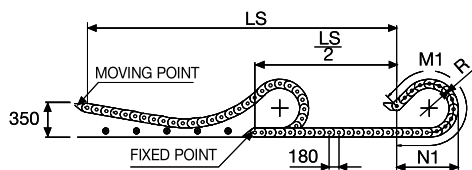
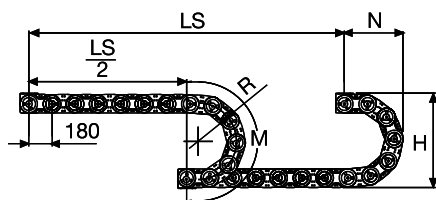

R	H*	N	M	N1	M1
mm	mm	mm	mm	mm	mm
250	650	510	1150	1545	3285
300	750	555	1305	1755	3790
350	850	605	1460	1950	4265
400	950	655	1620	2125	4715
450	1050	710	1780	2295	5150
500	1150	755	1930	2455	5570
550	1250	805	2090	2605	5975
600	1350	855	2245	2755	6375
700	1550	955	2560	3035	7155
750	1650	1010	2720	3170	7535
850	1850	1105	3030	3430	8280
1000	2150	1255	3500	-	-

\* The height H should be increased by 10 mm/m approx. because of preload. In case of limitation to the available space, refer to the Technical Dptm.

Length of chain (L)

Half travel distance ( $\frac{LS}{2}$ )

plus length of curve (M) or (M1)

$$L = \frac{LS}{2} + M \text{ or } M1$$

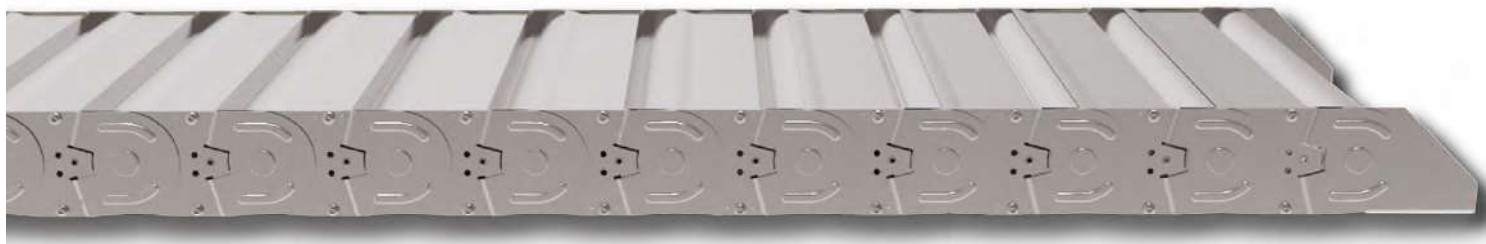



### Self-Supporting Capacity Diagram

The maximum length of the self-supporting capacity ( $\frac{LS}{2}$ ) in relationship to the weight of the cables and hoses contained per linear metre.

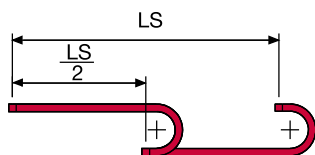
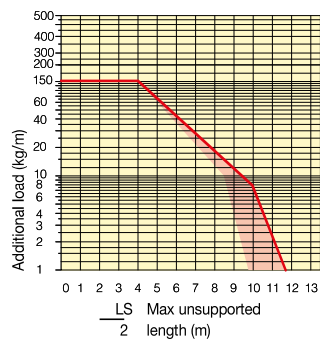

The red marking in the diagram area considers the difference of weight between various widths of chain.

For applications with  $\frac{LS}{2}$  and weights not included in the area of the diagram showing self-supporting capacity, verify the possible use of support rollers (see page 30).

### Bright Zinc Plated Steel End Brackets

The end brackets set, containing four steel plates screwed to the links allows the two ends of the chain to be attached to the equipment.

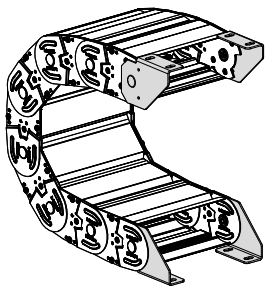
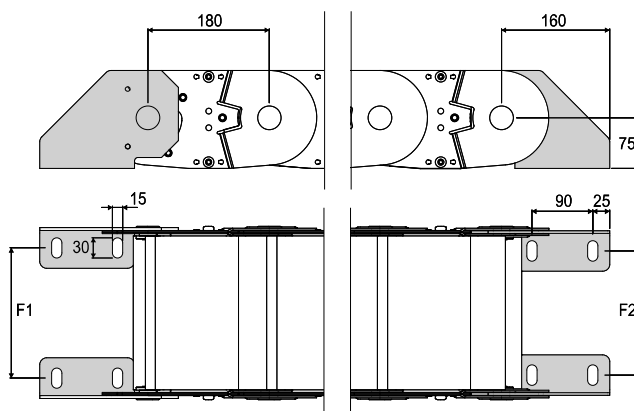

Fig. A  
Chain fixed outer radius (Fig A)  
See mounting variations page 31



Chain type	F1 mm	F2 mm
40LC150	144	135
40LC200	194	185
40LC250	244	235
40LC300	294	285
40LC400	394	385
40LC500	494	485

Special Widths  
F1=A-64 F2=A-73

### Bright Zinc Plated Steel Type Part Numbers

Complete Set Assembled	Chain	End Brackets
Type	Set	
40LC	A40LCKM □ *	

Complete Set Unassembled	Chain	End Brackets
Type	Set	
40LC	A40LCK	

\*\* 1=Pos.1; 2=Pos.2; 3=Pos.3  
Mount Variant page 31

### Serie Steel

## 40LC

Zinc plated steel chain with aluminium cover

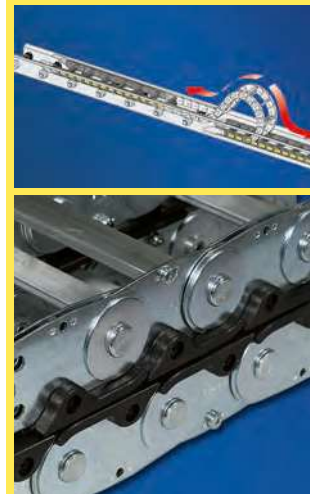

Suitable to long travel distance  
See page 243

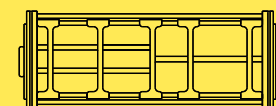

Supplementary movable separators.



For further information please consult Brevetti Stendalto's Technical Office

## 42LT

### Bright zinc plated steel cable chain with Alu-frames

#### Inner height (D) 138 mm

Bright Zinc Plated Steel Cable Chain.<sup>1</sup>  
Aluminium Holed cross pieces designed or Alu-frame are mounted every link.  
Quote C can be in special size.

<sup>(1)</sup> available in Stainless Steel.

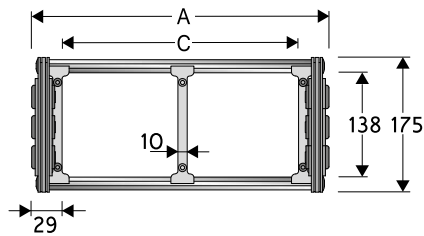

#### Separator

- Unassembled	Part.no S42TCF9
- Assembled	Part.no S42TCF9MC

#### Technical characteristics when self-supported

Speed	0,5 m/s
Acceleration	2 m/s <sup>2</sup>

For higher requirements please consult our technical dept.

For sliding applications, characteristics techniques may vary depending on the frequency, added weight and work environment.

#### Aluminium draw plates with nylon separators

A	B	C	D	R	Weight/m	Chain
mm	mm	mm	mm	mm	kg	Part Number
208	175	150	138	250-300-350-400-450-500-550-600-700-750-850	22,84	42LT150 □□□ *
258	175	200	138	250-300-350-400-450-500-550-600-700-750-850	23,30	42LT200 □□□ *
308	175	250	138	250-300-350-400-450-500-550-600-700-750-850	23,76	42LT250 □□□ *
358	175	300	138	250-300-350-400-450-500-550-600-700-750-850	24,22	42LT300 □□□ *
458	175	400	138	250-300-350-400-450-500-550-600-700-750-850	25,15	42LT400 □□□ *
558	175	500	138	250-300-350-400-450-500-550-600-700-750-850	26,07	42LT500 □□□ *
C+58	175	....	138	250-300-350-400-450-500-550-600-700-750-850		42LT □□□ □□□ **

\*Complete the code by inserting the value of the radius (R): 42LT150 □ □ □ □

\*\*Complete the code by inserting the value of the quota C and the radius (R): Es. 42LT □ □ □ □ □ □ □ □

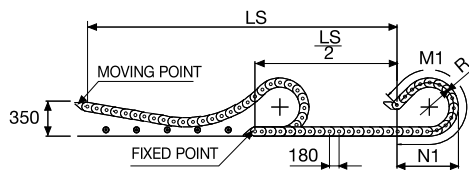
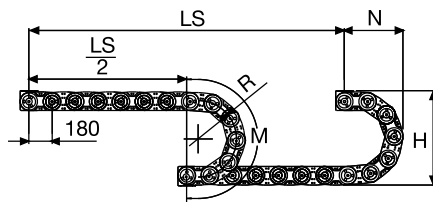

Length of chain (L)

Half travel distance ( $\frac{LS}{2}$ )

plus length of curve (M) or (M1)

$$L = \frac{LS}{2} + M \text{ or } M1$$

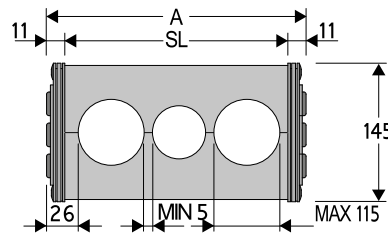

#### Machined Cross Frame

Machined cross frames (42LA) available on request for bending radius listed below. Custom solutions for machined cross frames realization, based on customer's and/or specific requirements. Please contact Brevetti Stendalto's Technical Department for further information.

R	H*	N	M	N1	M1
mm	mm	mm	mm	mm	mm
250	720	510	1150	1545	3285
300	820	555	1305	1755	3790
350	920	605	1460	1950	4265
400	1020	655	1620	2125	4715
450	1120	710	1780	2295	5150
500	1220	755	1930	2455	5570
550	1320	805	2090	2605	5975
600	1420	855	2245	2755	6375
700	1620	955	2560	3035	7155
750	1720	1010	2720	3170	7535
850	1920	1105	3030	3430	8280
1000	2220	1255	3500	-	-

\*The height H should be increased by 10 mm/m approx. because of preload. In case of limitation to the available space, refer to the Technical Deptm.



### Self-Supporting Capacity Diagram

The maximum length of the self-supporting capacity ( $\frac{LS}{2}$ ) in relationship to the weight of the cables and hoses contained per linear metre.

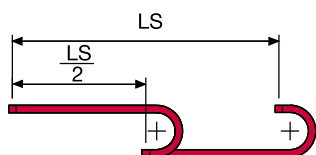
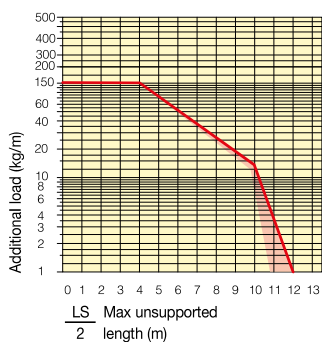

The red marking in the diagram area considers the difference of weight between various widths of chain.

For applications with  $\frac{LS}{2}$  and weights not included in the area of the diagram showing self-supporting capacity, verify the possible use of support rollers (see page 30).

### Bright Zinc Plated Steel End Brackets

The end brackets set, containing four steel plates screwed to the links allows the two ends of the chain to be attached to the equipment.

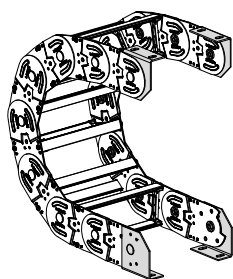
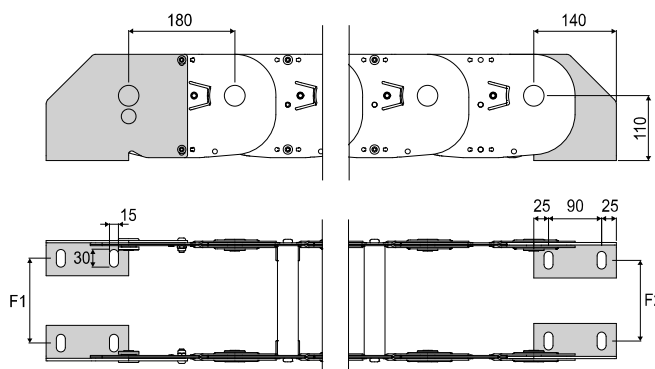

Fig. A  
Chain fixed outer radius (Fig A). See mounting variations page 31



Chain Type	F1 mm
42LT150	144
42LT200	194
42LT250	244
42LT300	294
42LT400	394
42LT500	494
Special Widths	F=A-64

Chain type	F2 mm
42LT150	135
42LT200	185
42LT250	235
42LT300	285
42LT400	385
42LT500	485
Special Widths	F=A-73

### Bright Zinc Plated Steel Type Part Numbers

Chain type	End Brackets Set
42LT...	A42LKM □ **

Chain type	End Brackets Set
42LT...	A42LK

\*\* 1=Pos.1; 2=Pos.2; 3=Pos.3  
See mounting variations page 31

### Serie Steel

## 42LT

Bright zinc plated steel cable chain with Alu-frames

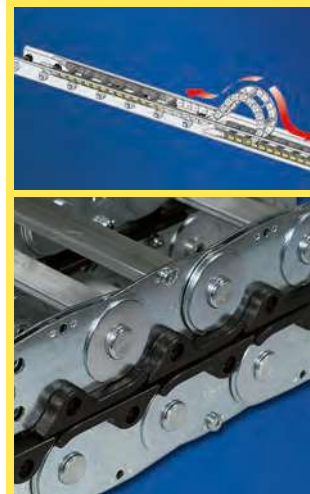

Suitable to long travel distance  
See page 243



For further information please consult Brevetti Stendato's Technical Office

## 45LT Zinc plated steel cable chain with Alu-frames

### Inner height (D) 182 mm

Zinc Plated Steel Cable Chain.<sup>1</sup>  
Aluminium Holed cross pieces designed  
or Alu-frame are mounted every link.

Quote C can be in special size.

<sup>(1)</sup> available in Stainless Steel.

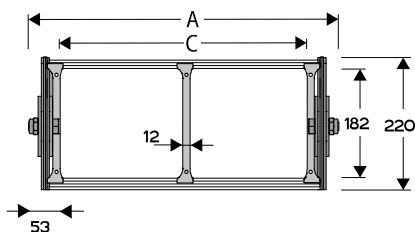

### Separator

- Unassembled	Part.no ST4500F1C
- Assembled	Part.no ST4500F1CMC

### Technical characteristics when self-supported

Speed	0,5 m/s
Acceleration	2 m/s <sup>2</sup>

For higher requirements please consult our  
technical dept.

For sliding applications, characteristics  
techniques may vary depending on the  
frequency, added weight and work environment.

### Aluminium draw plates with nylon separators

A	B	C	D	R	Weight/m	Chain
mm	mm	mm	mm	mm	kg	Part Number
406	220	300	182	400-500-600-650-800-1000-1250-1500	42,40	45LT300 □□□ *
456	220	350	182	400-500-600-650-800-1000-1250-1500	42,77	45LT350 □□□ *
506	220	400	182	400-500-600-650-800-1000-1250-1500	43,10	45LT400 □□□ *
556	220	450	182	400-500-600-650-800-1000-1250-1500	43,44	45LT450 □□□ *
606	220	500	182	400-500-600-650-800-1000-1250-1500	43,77	45LT500 □□□ *
706	220	600	182	400-500-600-650-800-1000-1250-1500	44,43	45LT600 □□□ *
C+106	220	....	182	400-500-600-650-800-1000-1250-1500	....	45LT □□□□□ **

\*Complete the code by inserting the value of the radius (R): Ex. 45LT300 □□□ □□

\*\*Complete the code by inserting the value of the quote C and the radius (R): Ex. 45LT □□□ □□ □□ □□

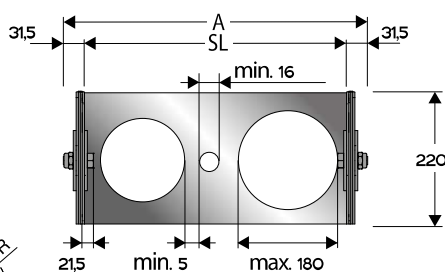
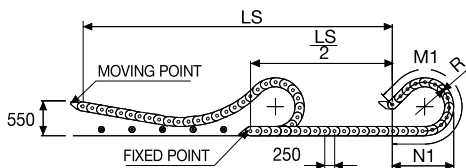
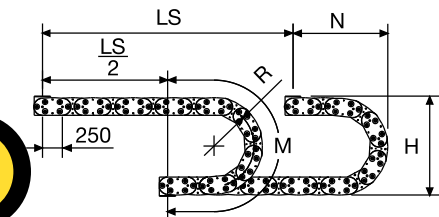

R	H*	N	M	N1	M1
mm	mm	mm	mm	mm	mm
400	1032	770	1760	2510	5330
500	1232	870	2070	2940	3635
600	1432	970	2390	3325	7315
650	1532	1020	2540	3505	7770
800	1832	1170	3020	4010	9075
1000	2232	1370	3650	4625	10710
1250	2732	1620	4430	5330	12655
1500	3232	1865	5215	5985	14525

\* The height H should be increased by 10 mm/m  
approx. because of preload. In case of limitation to  
the available space, refer to the Technical Dpmt.

### Machined Cross Frame

Machined cross frames (45LA) available on  
request for bending radius listed below.  
Custom solutions for machined cross  
frames realization, based on customer's  
and/or specific requirements.  
Please contact Brevetti Stendalto's  
Technical Department for further  
information.

Length of chain (L)

Half travel distance ( $\frac{LS}{2}$ )

plus length of curve (M) o (M1)

$$L = \frac{LS}{2} + M \text{ o } M1$$



### Self-Supporting Capacity Diagram

The maximum length of the self-supporting capacity ( $\frac{LS}{2}$ ) in relationship to the weight of the cables and hoses contained per linear metre.

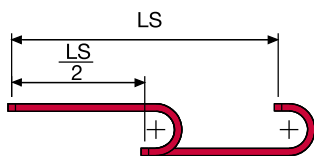
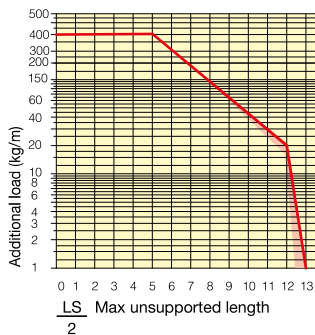

The red marking in the diagram area considers the difference of weight between various widths of chains.

For applications with  $\frac{LS}{2}$  and weights not included in the area of the diagram showing self-supporting capacity, verify the possible use of support rollers (see page 30).

### Bright Zinc Plated Steel End Brackets

The end brackets set, containing four steel plates screwed to the links allows the two ends of the chain to be attached to the equipment.

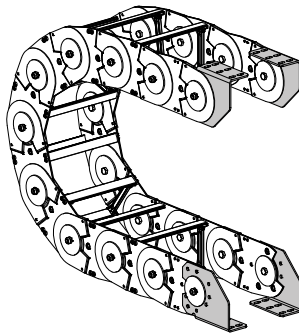
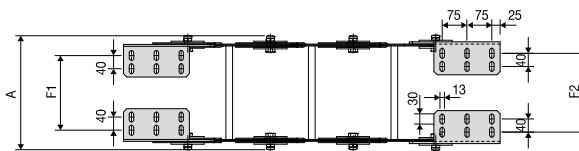
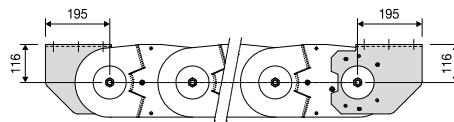

Fig. A Chain fixed outside the radius. (Fig A) See end brackets mounting variations page 31.



Chain Type	F1 mm
45LT300	299
45LT350	349
45LT400	399
45LT450	449
45LT500	499
45LT600	599
Special widths	F= A-107

Chain Type	F2 mm
45LT300	287
45LT350	337
45LT400	387
45LT450	437
45LT500	487
45LT600	587
Special widths	F= A-119

### Bright Zinc Plated Steel Type Part Numbers

Complete Set Assembled	
Chain Type	End Brackets Set
45LT	A45LKM□ **

Complete Set Unassembled	
Chain Type	End Brackets Set
45LT	A45LK

\*\* 1=Pos.1; 2=Pos.2; 3=Pos.3  
See end brackets mounting variations page 31.

### Serie Steel

## 45LT

Zinc plated steel cable chain with Alu-frames

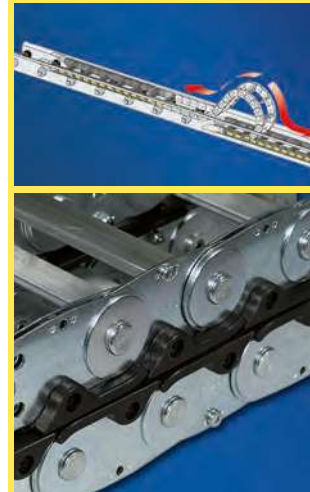

Suitable to long travel distance.

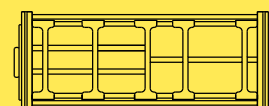

Supplementary movable separators.



For further information please consult Brevetti Stendaito's Technical Office





Sliding low-friction skirts fastened to the links allow chains running on themselves, all the while granting them to get more longer strokes. Aluminium Draw Plates with nylon separations or aluminium split cross piece created by design. Separators system available.

<sup>(1)</sup> Available in Stainless steel

## 30LPT with aluminium draw plates

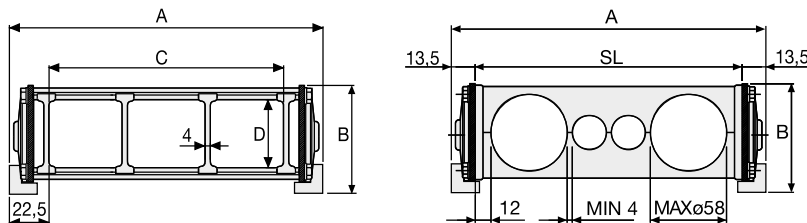

A	B	C	D	R	Weight/m	Chain
mm	mm	mm	mm	mm	kg	Part Number
151	81,5	106	52	150-220-250-305-400-535	6,71	30LPT106□□□*
201	81,5	156	52	150-220-250-305-400-535	6,95	30LPT156□□□*
251	81,5	206	52	150-220-250-305-400-535	7,20	30LPT206□□□*
301	81,5	256	52	150-220-250-305-400-535	7,44	30LPT256□□□*
351	81,5	306	52	150-220-250-305-400-535	7,68	30LPT306□□□*
401	81,5	356	52	150-220-250-305-400-535	7,92	30LPT356□□□*
451	81,5	406	52	150-220-250-305-400-535	8,16	30LPT406□□□*
501	81,5	456	52	150-220-250-305-400-535	8,41	30LPT456□□□*
551	81,5	506	52	150-220-250-305-400-535	8,65	30LPT506□□□*
C+45	81,5	....	52	150-220-250-305-400-535		30LPT□□□□□□**

\*Complete the code by inserting the value of the radius (R): Ex. 30LPT156□□□\*

\*\*Complete the code by inserting the value of the quote C and the radius (R): Ex. 30LPT□□□□□\*

Chain equipped with aluminium draw plates every pitch: complete the code by inserting the letter D: Ex. 30LPT156250□\*

### Aluminium split cross pieces created by design

A	B	R	Chain
mm	mm	mm	Part Number
SL+27	81,5	150-220-250-305-400-535	30LPA□□□□□□***

\*\*\*Complete the code by inserting the value of the SL and the radius (R): Es. 30LPA□□□□□□

## 30LPC with aluminium covers

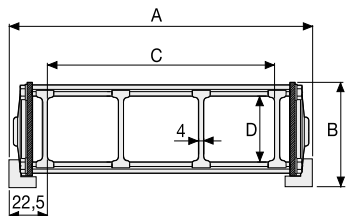

A	B	C	D	R	Weight/m	Chain
mm	mm	mm	mm	mm	kg	Part Number
151	81,5	106	52	150-220-250-305-400-535	8,38	30LPC106□□□*
201	81,5	156	52	150-220-250-305-400-535	9,30	30LPC156□□□*
251	81,5	206	52	150-220-250-305-400-535	10,21	30LPC206□□□*
301	81,5	256	52	150-220-250-305-400-535	11,13	30LPC256□□□*
351	81,5	306	52	150-220-250-305-400-535	12,04	30LPC306□□□*
401	81,5	356	52	150-220-250-305-400-535	12,95	30LPC356□□□*
451	81,5	406	52	150-220-250-305-400-535	13,87	30LPC406□□□*
501	81,5	456	52	150-220-250-305-400-535	14,79	30LPC456□□□*
551	81,5	506	52	150-220-250-305-400-535	15,70	30LPC506□□□*
C+45	81,5	....	52	150-220-250-305-400-535		30LPC□□□□□□**

\*Complete the code by inserting the value of the radius (R): Ex. 30LPC156□□□\*

\*\*Complete the code by inserting the value of the quote C and the radius (R): Ex. 30LPC□□□□□\*



For further information please consult Brevetti Stendato's Technical Office

## Sliding cable chains in bright zinc plated steel

### Technical characteristics when self-supported

Speed	2 m/s
Acceleration	2 m/s <sup>2</sup>

For higher requirements please consult our technical dept.

### 35LPT with aluminium draw plates

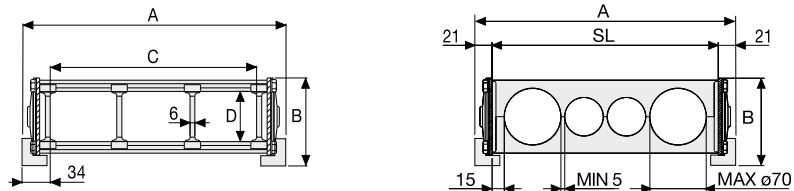

A	B	C	D	R	Weight/m	Chain
mm	mm	mm	mm	mm	kg	Part Number
172	107	104	65	200-250-300-350-400-450-500-600	11,49	35LPT104 □□□ *
222	107	154	65	200-250-300-350-400-450-500-600	11,86	35LPT154 □□□ *
272	107	204	65	200-250-300-350-400-450-500-600	12,23	35LPT204 □□□ *
322	107	254	65	200-250-300-350-400-450-500-600	12,60	35LPT254 □□□ *
372	107	304	65	200-250-300-350-400-450-500-600	12,97	35LPT304 □□□ *
422	107	354	65	200-250-300-350-400-450-500-600	13,33	35LPT354 □□□ *
472	107	404	65	200-250-300-350-400-450-500-600	13,70	35LPT404 □□□ *
522	107	454	65	200-250-300-350-400-450-500-600	14,07	35LPT454 □□□ *
572	107	504	65	200-250-300-350-400-450-500-600	14,44	35LPT504 □□□ *
C+68	107	....	65	200-250-300-350-400-450-500-600		35LPT □□□□□ **

\*Complete the code by inserting the value of the radius (R): Ex. 35PT154 3 5 0

\*\*Complete the code by inserting the value of the quote C and the radius (R): Ex. 35PT 7 2 3 3 5 0

Chain equipped with aluminium draw plates every pitch: complete the code by inserting the letter D. Ex. 35LT154350 D

### Aluminium split cross pieces created by design

A	B	R	Chain
mm	mm	mm	Part Number
SL+42	107	200-250-300-350-400-450-500-600	35LPA □□□□□ ***

\*\*\*Complete the code by inserting the value of SL and the radius (R): Ex. 35LPA 7 5 0 2 5 0

### 35LPC with aluminium covers

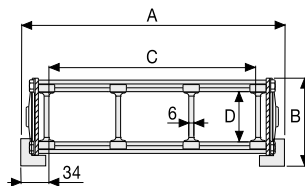

A	B	C	D	R	Weight/m	Chain
mm	mm	mm	mm	mm	kg	Part Number
172	107	104	65	200-250-300-350-400-450-500-600	13,26	35LPC104 □□□ *
222	107	154	65	200-250-300-350-400-450-500-600	14,29	35LPC154 □□□ *
272	107	204	65	200-250-300-350-400-450-500-600	15,32	35LPC204 □□□ *
322	107	254	65	200-250-300-350-400-450-500-600	16,35	35LPC254 □□□ *
372	107	304	65	200-250-300-350-400-450-500-600	17,38	35LPC304 □□□ *
422	107	354	65	200-250-300-350-400-450-500-600	18,41	35LPC354 □□□ *
472	107	404	65	200-250-300-350-400-450-500-600	19,44	35LPC404 □□□ *
522	107	454	65	200-250-300-350-400-450-500-600	20,46	35LPC454 □□□ *
572	107	504	65	200-250-300-350-400-450-500-600	21,49	35LPC504 □□□ *
C+68	107	....	65	200-250-300-350-400-450-500-600		35LPC □□□□□ **

\*Complete the code by inserting the value of the radius (R): Ex. 35LPC154 2 5 0

\*\*Complete the code by inserting the value of the quote C and the radius (R): Ex. 35LPC 7 2 3 2 5 0







Sliding low-friction skids fastened to the links allow chains running on themselves, all the while granting them to get more longer strokes. Aluminium Draw Plates with nylon separations or aluminium split cross piece created by design. Separators system available.

<sup>(1)</sup> Available in Stainless steel

## 40LPT with aluminium draw plates

A	B	C	D	R	Weight/m	Chain
mm	mm	mm	mm	mm	kg	Part Number
230	161,5	150	112,5	250-300-350-400-450-500-550-600-700-750-850	20,71	40LPT150 □□□ *
280	161,5	200	112,5	250-300-350-400-450-500-550-600-700-750-850	21,17	40LPT200 □□□ *
330	161,5	250	112,5	250-300-350-400-450-500-550-600-700-750-850	21,63	40LPT250 □□□ *
380	161,5	300	112,5	250-300-350-400-450-500-550-600-700-750-850	22,09	40LPT300 □□□ *
480	161,5	400	112,5	250-300-350-400-450-500-550-600-700-750-850	23,02	40LPT400 □□□ *
580	161,5	500	112,5	250-300-350-400-450-500-550-600-700-750-850	23,94	40LPT500 □□□ *
C+80	161,5	....	112,5	250-300-350-400-450-500-550-600-700-750-850		40LPT □□□ □□□ **

\*Complete the code by inserting the value of the radius (R): Ex. 40LPT150 □ □ □ \*

\*\*Complete the code by inserting the value of the quote C and the radius (R): Ex. 40LPT □ □ □ □ □ □ \*\*

### Aluminium split cross pieces created by design

A	B	R	Chain
mm	mm	mm	Part Number
SL+44	161,5	250-300-350-400-450-500-550-600-700-750-850	40LPA □ □ □ □ □ □ ***

\*\*\*Complete the code by inserting the value of SL and of the radius (R): Ex. 40LTA □ □ □ □ □ □ □ □ □ □

## 40LPC with aluminium covers

A	B	C	D	R	Weight/m	Chain
mm	mm	mm	mm	mm	kg	Part Number
230	161,5	150	104	250-300-350-400-450-500-550-600-700-750-850	23,96	40LPC150 □ □ □ *
280	161,5	200	104	250-300-350-400-450-500-550-600-700-750-850	25,33	40LPC200 □ □ □ *
330	161,5	250	104	250-300-350-400-450-500-550-600-700-750-850	26,69	40LPC250 □ □ □ *
380	161,5	300	104	250-300-350-400-450-500-550-600-700-750-850	28,05	40LPC300 □ □ □ *
480	161,5	400	104	250-300-350-400-450-500-550-600-700-750-850	30,77	40LPC400 □ □ □ *
580	161,5	500	104	250-300-350-400-450-500-550-600-700-750-850	33,50	40LPC500 □ □ □ *
C+80	161,5	....	104	250-300-350-400-450-500-550-600-700-750-850		40LPC □ □ □ □ □ □ **

\*Complete the code by inserting the value of the radius (R): Ex. 40LPC150 □ □ □ \*

\*\*Complete the code by inserting the value of the quote C and the radius (R): Ex. 40LPC □ □ □ □ □ □ □ □ □ □

## 42LPT with aluminium covers

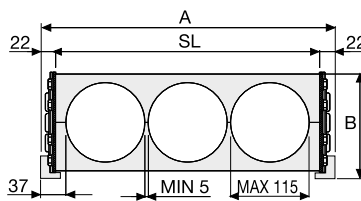
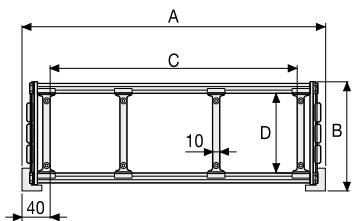

A	B	C	D	R	Weight/m	Chain
mm	mm	mm	mm	mm	kg	Part Number
230	191,5	150	138	250-300-350-400-450-500-550-600-700-750-850	24,25	42LPT150 □ □ □ *
280	191,5	200	138	250-300-350-400-450-500-550-600-700-750-850	24,71	42LPT200 □ □ □ *
330	191,5	250	138	250-300-350-400-450-500-550-600-700-750-850	25,17	42LPT250 □ □ □ *
380	191,5	300	138	250-300-350-400-450-500-550-600-700-750-850	25,63	42LPT300 □ □ □ *
430	191,5	400	138	250-300-350-400-450-500-550-600-700-750-850	26,56	42LPT400 □ □ □ *
580	191,5	500	138	250-300-350-400-450-500-550-600-700-750-850	27,48	42LPT500 □ □ □ *
C+80	191,5	....	138	250-300-350-400-450-500-550-600-700-750-850		42LPT □ □ □ □ □ □ **

\*Complete the code by inserting the value of the radius (R): Ex. 42LPT150 □ □ □ \*

\*\*Complete the code by inserting the value of the quote C and the radius (R): Ex. 42LPT □ □ □ □ □ □ □ □ □ □

## 40LPT

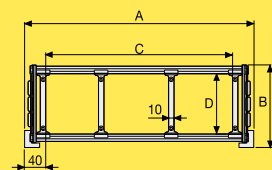

## 40LPA

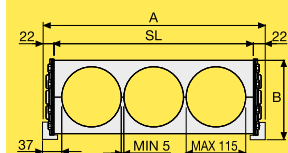

## 40LPC

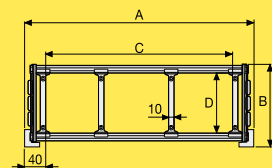

For further information please consult Brevetti Stendalto's Technical Office

# Cable Drag Chains in Steel for Long Travel Distance

The use of cable chains in applications with particularly long travel distances offers many benefits. The possibilities of the combined transportation of high power cables, signal cables and hydraulic hoses, together with ease of use and no need for maintenance, are the unquestionable advantages of the system. Specific applications, characterised by particularly aggressive conditions in the environment, require cable chains in steel. Brevetti Stendalto has offered for many years, with positive results their own system based on the use of two steel drag chains and a travelling internal supporting frame. The chains are arranged in a closed loop configuration, having

a fixed bracket and a movable towing bracket. A secondary similar closed loop, made of steel wire rope, drives the supporting frame along the entire travel at a suitable speed, thus ensuring a continuous support to relieve all stresses. In addition to this a trough is arranged to contain and guide the chain system along the total travel. The chains are fitted with wheels on ball bearings, to keep to a minimum the friction on the supporting frame. The supporting frame can be made both in galvanised steel, or if requested, in stainless steel.

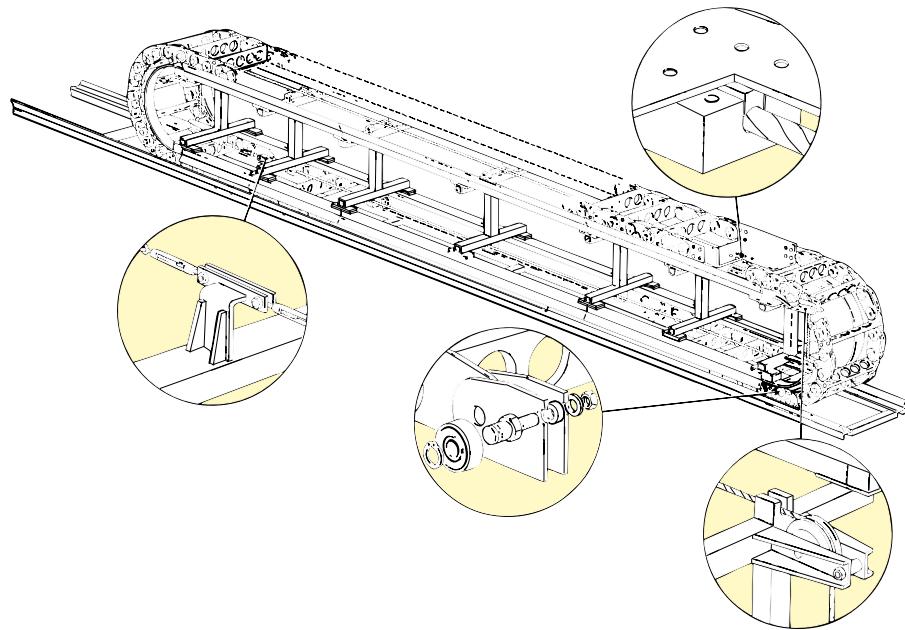

5

35 chains with supporting frame applied to De Icing equipment at München airport (Germany). The length of the travel distance is 90 m and it's velocity is 90 m per minute.



# Special off-shore Applications

The Brevetti Stendalto steel cable chains have been used in Off-shore applications for many years. The high standard of quality required and the special materials needed are characteristics in these kinds of applications.

On request cable chains of special dimensions which have been personalised according to the clients needs are being used.



Platform "Oseberg"

A: 45 chain in stainless steel 316L

B: 45 chain in stainless steel 316L for rotations of  $\pm 180^\circ$



Platform "Tiffany"

Specially designed chains in stainless steel 316L  
Length of travel distance: 27 m  
Total weight of the chains: 13 Ton.